











B&G

PRICE LIST







SAILING ELECTRONICS

















Zeus³ GH







Main Products

| Part Number | Description | RRP excl. (EUR) | RRP incl. (19.0%) |
|---------------|-----------------------------------------------------------------------------------------------------------------------------------------------------------------------------------------------------------------------------------------------------------------------------------------------------------------------------------------------------------------------------------------------------------------------------------------------------------------------------------------------------------|-----------------|-------------------|
| 000-15129-001 |  B&G Zeus ³ S Glass Helm 16" System Pack. Includes Zeus ³ S 16" Multifunction display, MI10 card reader and ZC2 controller: Designed specifically for blue water sailing, multihulls and superyachts, this premium, super-fast, large-screen, multifunction display sits at the heart of your fully integrated navigation system, and provides easy-to-use touchscreen and remote control options. | 6618.10 | 7875.54 |
| 000-15130-001 |  B&G Zeus ³ S Glass Helm 19" System Pack. Includes Zeus ³ S 19" Multifunction display, MI10 card reader and ZC2 controller: Designed specifically for blue water sailing, multihulls and superyachts, this premium, super-fast, large-screen, multifunction display sits at the heart of your fully integrated navigation system, and provides easy-to-use touchscreen and remote control options. | 7699.20 | 9162.05 |
| 000-15131-001 |  B&G Zeus ³ S Glass Helm 24" System Pack. Includes Zeus ³ S 24" Multifunction display, MI10 card reader and ZC2 controller: Designed specifically for blue water sailing, multihulls and superyachts, this premium, super-fast, large-screen, multifunction display sits at the heart of your fully integrated navigation system, and provides easy-to-use touchscreen and remote control options. | 10608.30 | 12623.88 |
| 000-15048-001 |  B&G Zeus ³ S GH 16" Display Only: Designed specifically for blue water sailing, multihulls and superyachts, this premium, super-fast, large-screen, multifunction display sits at the heart of your fully integrated navigation system, and provides easy-to-use touchscreen and remote control options. | 6066.45 | 7219.08 |
| 000-15050-001 |  B&G Zeus ³ S GH 19" Display Only: Designed specifically for blue water sailing, multihulls and superyachts, this premium, super-fast, large-screen, multifunction display sits at the heart of your fully integrated navigation system, and provides easy-to-use touchscreen and remote control options. | 7180.00 | 8544.20 |
| 000-15052-001 |  B&G Zeus ³ S GH 24" Display Only: Designed specifically for blue water sailing, multihulls and superyachts, this premium, super-fast, large-screen, multifunction display sits at the heart of your fully integrated navigation system, and provides easy-to-use touchscreen and remote control options. | 10024.20 | 11928.80 |
| 000-12365-001 |  B&G ZC2 Remote controller. (Portrait mount). For use with ZEUS ^{2/3} , ZEUS ^{2/3} Glass Helm and Vulcan MFD systems and brings simple and precise MFD control in even the roughest sea conditions. | 440.00 | 523.60 |
| 000-12513-001 |  B&G ZC2 Remote controller. (Landscape mount) For use with ZEUS ^{2/3} , ZEUS ^{2/3} Glass Helm and Vulcan MFD systems and brings simple and precise MFD control in even the roughest sea conditions.. | 490.00 | 583.10 |









Accessories



| Part Number | Description | RRP excl. (EUR) | RRP incl. (19.0%) |
|---------------|----------------------------------------------------------------------------------------------------------------------------------------------------------------------------------------------------------------------------------------------------------------------------------------------------------------------------------------------------------------------------|-----------------|-------------------|
| 000-12607-001 |  Precision-9 Compass - Outputs Heading, Rate Of Turn, Roll and Pitch over the NMEA 2000® network. | 669.00 | 796.11 |
| 000-13294-001 |  Triton ² Digital Display - Multi-purpose 4.1 inch colour sailing instrument and autopilot display. | 515.00 | 612.85 |
| 000-11674-001 |  ForwardScan™ Transducer Kit with Sleeve & Plug. 10m (33ft) Cable | 769.00 | 915.11 |
| 000-15793-001 |  B&G V100-B Blackbox VHF Radio System - featuring a built-in GPS and Class B AIS transceiver, which allows you to see and be seen by AIS-equipped vessels. Stay connected from anywhere on board with up to 8 handsets (4 wired and 4 wireless) and 4 external speakers. | 1574.00 | 1873.06 |
| 000-14492-001 |  B&G V20S Class D DSC VHF Radio - The versatile V20S is ideal for a variety of boats from small yachts to larger cruisers and racing boats, and is designed to match the low-profile style of our chartplotters and accessories. | 334.00 | 397.46 |
| 000-14380-001 |  The V3100 Class B AIS incorporates SOTDMA technology and increased transmission power to enhance transmission frequency, reliability, and range compared to standard Class B AIS. This 'black-box' solution integrates with MFD displays, and features industry-standard connectivity. | 935.00 | 1112.65 |

| Part Number | Description | RRP excl. (EUR) | RRP incl. (19.0%) |
|---------------|-------------------------------------------------------------------------------------------------------------------------------------------------------------------------------------------------------------------------------------------------------------------------------------------------------------------------------------------------|-----------------|-------------------|
| 000-14382-001 |  WS310 Wired Wind Sensor with 20m (65.5ft) mast cable and interface for connection to the NMEA 2000® network. | 549.00 | 653.31 |
| 000-14843-001 |  WS310 Wired Wind Sensor with 35m (115ft) mast cable and interface for connection to the NMEA 2000® network. | 587.00 | 698.53 |
| 000-13963-001 |  NAIS-500 Class B AIS including NSPL500 VHF/AIS Antenna splitter and GPS500 antenna. Broadcast your location to anyone nearby with an AIS Receiver. A low cost safety system for recreational vessels and smaller professional vessels in near coastal waters. | 1099.00 | 1307.81 |
| 000-15644-001 |  B&G V100 Blackbox VHF Radio System - Stay safer on the water with the B&G V100 VHF marine radio. With up to 8 connected handsets (4 wired and 4 wireless) and 4 external speakers, stay connected from anywhere on board. | 940.00 | 1118.60 |
| 000-14540-001 |  HALO20 Radar - A cost-effective compact 20" Radar dome. 24nm range and 24RPM. The perfect radar solution for budget-conscious sailors with smaller vessels. | 2050.00 | 2439.50 |
| 000-15876-001 |  The IP CAM-1 marine grade 316 stainless steel IP camera. Powered by 12V DC or PoE. | 559.00 | 665.21 |
| 000-15974-001 |  Sail Performance sensor pack. Includes WS320 wind pack, IDST-850 transducer, ZG100 GPS antenna, and Micro-C backbone kit and cables. | 1427.00 | 1698.13 |
| 000-15134-001 |  Triton™ Edge Sailing Processor with NMEA 2000®, Ethernet and built-in Wi-Fi. | 1510.00 | 1796.90 |
| 000-14539-001 |  HALO20+ Radar - A compact 20" powerful 25W Solid-State Radar, delivering 60RPM at short range and up to 36nm range. Identify hazards in an instant with VelocityTrack™ Doppler technology and can run dual scale to identify hazards long and far. | 2410.00 | 2867.90 |
| 000-14383-001 |  WS320 Wireless Wind Sensor including Wireless Interface for connection to NMEA 2000® networks. For masts up to 25m in height. | 659.00 | 784.21 |
| 000-11542-001 |  H5000 Graphic Display - A 5-inch colour display with a straightforward user interface packed with unique sailing features including SailSteer and Start Line. | 1070.00 | 1273.30 |
| 000-14538-001 |  HALO24 Radar - A 24" powerful 25W Solid-State Radar, delivering 60RPM at short range and up to 48nm range. Identify hazards in an instant with VelocityTrack™ Doppler technology and can run dual scale to identify hazards long and far. | 2700.00 | 3213.00 |
| 000-13335-001 |  NAC-2 Autopilot Core Pack - Comes with NAC-2 Autopilot Computer, Precision-9 Compass and RF-25N Rudder Feedback unit. | 1620.83 | 1928.79 |
| 000-13337-001 |  NAC-2 VRF Autopilot Core Pack - Comes with NAC-2 Autopilot Computer and Precision-9 Compass. | 1354.17 | 1611.46 |
| 000-13336-001 |  NAC-3 Autopilot Core Pack - Comes with NAC-3 Autopilot Computer, Precision-9 Compass and RF-25N Rudder Feedback unit. | 2379.17 | 2831.21 |
| 000-13338-001 |  NAC-3 VRF Autopilot Core Pack - Comes with NAC-3 Autopilot Computer and Precision-9 Compass. | 2108.33 | 2508.92 |
| 000-10029-001 |  NEP-2 Network Expansion Port (Ethernetverteiler mit 5 Ports) | 309.00 | 367.71 |

| Part Number | Description | RRP excl. (EUR) | RRP incl. (19.0%) |
|---------------|-------------------------------------------------------------------------------------------------------------------------------------------------------------------------------------------------------------------------------------------------|-----------------|-------------------|
| 000-0127-51 |  Ethernetkabel yellow 5 Pin 1.8 m (6 ft) | 38.00 | 45.22 |
| 000-0127-29 |  Ethernetkabel yellow 5 Pin 4.5 m (15 ft) | 56.00 | 66.64 |
| 000-0127-30 |  Ethernetkabel yellow 5 Pin 7.7 m (25 ft) | 79.00 | 94.01 |
| 000-0127-37 |  Ethernetkabel yellow 5 Pin 15.2 m (50 ft) | 109.00 | 129.71 |
| 24005729 |  SimNet to Micro-C (male) cable that connects a SimNet product to a NMEA 2000® backbone. 0.5 m (1.6 ft) | 38.00 | 45.22 |
| 000-14488-001 |  Spacer required if using the Heavy Duty Gimbal bracket kit (000-13547-001) to mount an NSO16 evo3 or ZEUS3-16 display.(not required for 19 and 24 " displays) | 51.49 | 61.27 |
| 000-12397-001 |  StructureScan® 3D module only. Transom mount and Through-Hull transducers available separately. | 648.00 | 771.12 |





Spare Parts

| Part Number | Description | RRP excl. (EUR) | RRP incl. (19.0%) |
|---------------|--------------------------------------------------------------------------------------------------------------------------------------------------------------------------------------------------------------------------------------------------------------------------------------------------------------------------------------------------------------------------------------------------------|-----------------|-------------------|
| 000-15050-001 |  B&G Zeus³S GH 19" Display Only: Designed specifically for blue water sailing, multihulls and superyachts, this premium, super-fast, large-screen, multifunction display sits at the heart of your fully integrated navigation system, and provides easy-to-use touchscreen and remote control options. | 7180.00 | 8544.20 |
| 000-15052-001 |  B&G Zeus³S GH 24" Display Only: Designed specifically for blue water sailing, multihulls and superyachts, this premium, super-fast, large-screen, multifunction display sits at the heart of your fully integrated navigation system, and provides easy-to-use touchscreen and remote control options. | 10024.20 | 11928.80 |
| 000-12365-001 |  B&G ZC2 Remote controller. (Portrait mount). For use with ZEUS²³, ZEUS²³ Glass Helm and Vulcan MFD systems and brings simple and precise MFD control in even the roughest sea conditions. | 440.00 | 523.60 |
| 000-14357-001 |  B&G Suncover for 16" Monitor | 92.70 | 110.31 |
| 000-11246-001 |  RJ45-Yellow Round Ethernet adapter cable RJ45 Male / 5 Pin Female 10 cm (6") | 24.00 | 28.56 |
| 000-14358-001 |  B&G Suncover for 19" Monitor | 108.15 | 128.70 |
| 000-14359-001 |  B&G Suncover for 24" Monitor | 133.90 | 159.34 |
| 000-11618-001 |  MO, NSO evo3 16/19/24 Rear mount bracket kit. Includes: dash seal for 16,19,24" and Bracket kit | 63.00 | 74.97 |
| 000-13892-001 |  MI10 Dashmount microSD card reader: Provides a dual Chart Card reader for use with NSO and Zeus MFD / MPU systems. | 219.00 | 260.61 |











| Part Number | Description | RRP excl. (EUR) | RRP incl. (19.0%) |
|---------------|---------------------------------------------------------------------------------------------------------------------------------|-----------------|-------------------|
| 000-12743-001 |  OP50 / ZC2 Suncover | 14.00 | 16.66 |
| 000-12744-001 |  OP50 / ZC2 Dash Mounting Kit | 14.00 | 16.66 |
| 000-11614-001 |  MO, NSO evo3 16/19/24 Cable retention bracket | 27.53 | 32.76 |

















Zeus^{2/3} GH MPU













Main Products

| Part Number | Description | RRP excl. (EUR) | RRP incl. (19.0%) |
|---------------|------------------------------------------------------------------------------------------------------------------------------------------------------------------------------------------------------------------------------------------------------------------------------------------------------------------------------------------------------------------------------------------------------------------------|-----------------|-------------------|
| 000-15125-001 |  Zeus ³ S MPU 1 x 16" Multi-Touch Monitor System base kit. Expand and integrate to build your preferred system including instrumentation, navigation, radar, sonar, autopilot, and more. Includes MPU, ZC2 Remote, MI10 Card Reader & ZG100 GPS Antenna. | 7771.45 | 9248.02 |
| 000-11736-001 |  B&G ZM16-T 15.6" Multi-Touch monitor with 1366x768 resolution. The 1000 nit peak brightness gives you a clear display even in direct sunlight, and the minimum brightness is extremely dim for night operation without blinding. Multiple video inputs and low-profile glass bridge design. | 3861.47 | 4595.15 |
| 000-11737-001 |  B&G ZM19-T. 19" Multi-Touch monitor with 1366x768 resolution. The 1000 nit peak brightness gives you a clear display even in direct sunlight, and the minimum brightness is extremely dim for night operation without blinding. Multiple video inputs and low-profile glass bridge design. | 5663.97 | 6740.12 |
| 000-15046-001 |  Zeus ³ S MPU - Expand and integrate to build your preferred system including instrumentation, navigation, radar, sonar, autopilot, and more. | 5084.07 | 6050.05 |
| 000-15104-001 |  Zeus ³ S MPU - Expand and integrate to build your preferred system including instrumentation, navigation, radar, sonar, autopilot, and more. | 5316.75 | 6326.93 |



Accessories





| Part Number | Description | RRP excl. (EUR) | RRP incl. (19.0%) |
|---------------|----------------------------------------------------------------------------------------------------------------------------------------------------------------------------------------------------------------------------------------------------------------------------------------------------------------------------------------------------------------------------|-----------------|-------------------|
| 000-11674-001 |  ForwardScan™ Transducer Kit with Sleeve & Plug. 10m (33ft) Cable | 769.00 | 915.11 |
| 000-12607-001 |  Precision-9 Compass - Outputs Heading, Rate Of Turn, Roll and Pitch over the NMEA 2000® network. | 669.00 | 796.11 |
| 000-13294-001 |  Triton ² Digital Display - Multi-purpose 4.1 inch colour sailing instrument and autopilot display. | 515.00 | 612.85 |
| 000-14380-001 |  The V3100 Class B AIS incorporates SOTDMA technology and increased transmission power to enhance transmission frequency, reliability, and range compared to standard Class B AIS. This 'black-box' solution integrates with MFD displays, and features industry-standard connectivity. | 935.00 | 1112.65 |
| 000-14492-001 |  B&G V20S Class D DSC VHF Radio - The versatile V20S is ideal for a variety of boats from small yachts to larger cruisers and racing boats, and is designed to match the low-profile style of our chartplotters and accessories. | 334.00 | 397.46 |
| 000-14382-001 |  WS310 Wired Wind Sensor with 20m (65.5ft) mast cable and interface for connection to the NMEA 2000® network. | 549.00 | 653.31 |
| 000-15793-001 |  B&G V100-B Blackbox VHF Radio System - featuring a built-in GPS and Class B AIS transceiver, which allows you to see and be seen by AIS-equipped vessels. Stay connected from anywhere on board with up to 8 handsets (4 wired and 4 wireless) and 4 external speakers. | 1574.00 | 1873.06 |
| 000-15644-001 |  B&G V100 Blackbox VHF Radio System - Stay safer on the water with the B&G V100 VHF marine radio. With up to 8 connected handsets (4 wired and 4 wireless) and 4 external speakers, stay connected from anywhere on board. | 940.00 | 1118.60 |
| 000-14540-001 |  HALO20 Radar - A cost-effective compact 20" Radar dome. 24nm range and 24RPM. The perfect radar solution for budget-conscious sailors with smaller vessels. | 2050.00 | 2439.50 |
| 000-15876-001 |  The IP CAM-1 marine grade 316 stainless steel IP camera. Powered by 12V DC or PoE. | 559.00 | 665.21 |

| Part Number | Description | RRP excl. (EUR) | RRP incl. (19.0%) |
|---------------|-----------------------------------------------------------------------------------------------------------------------------------------------------------------------------------------------------------------------------------------------------------------------------------------------------------------------------------------------------------------------------------------------------------|-----------------|-------------------|
| 000-14843-001 |  WS310 Wired Wind Sensor with 35m (115ft) mast cable and interface for connection to the NMEA 2000® network. | 587.00 | 698.53 |
| 000-13963-001 |  NAIS-500 Class B AIS including NSPL500 VHF/AIS Antenna splitter and GPS500 antenna. Broadcast your location to anyone nearby with an AIS Receiver. A low cost safety system for recreational vessels and smaller professional vessels in near coastal waters. | 1099.00 | 1307.81 |
| 000-13284-001 |  ForwardScan™ Transducer Kit (Long-Stem) with Sleeve & Plug. 10m (33ft) Cable | 1079.17 | 1284.21 |
| 000-15974-001 |  Sail Performance sensor pack. Includes WS320 wind pack, IDST-850 transducer, ZG100 GPS antenna, and Micro-C backbone kit and cables. | 1427.00 | 1698.13 |
| 000-15134-001 |  Triton™ Edge Sailing Processor with NMEA 2000®, Ethernet and built-in Wi-Fi. | 1510.00 | 1796.90 |
| 000-11736-001 |  B&G ZM16-T 15.6" Multi-Touch monitor with 1366x768 resolution. The 1000 nit peak brightness gives you a clear display even in direct sunlight, and the minimum brightness is extremely dim for night operation without blinding. Multiple video inputs and low-profile glass bridge design. | 3861.47 | 4595.15 |
| 000-14383-001 |  WS320 Wireless Wind Sensor including Wireless Interface for connection to NMEA 2000® networks. For masts up to 25m in height. | 659.00 | 784.21 |
| 000-14539-001 |  HALO20+ Radar - A compact 20" powerful 25W Solid-State Radar, delivering 60RPM at short range and up to 36nm range. Identify hazards in an instant with VelocityTrack™ Doppler technology and can run dual scale to identify hazards long and far. | 2410.00 | 2867.90 |
| 000-11737-001 |  B&G ZM19-T. 19" Multi-Touch monitor with 1366x768 resolution. The 1000 nit peak brightness gives you a clear display even in direct sunlight, and the minimum brightness is extremely dim for night operation without blinding. Multiple video inputs and low-profile glass bridge design. | 5663.97 | 6740.12 |
| 000-11542-001 |  H5000 Graphic Display - A 5-inch colour display with a straightforward user interface packed with unique sailing features including SailSteer and Start Line. | 1070.00 | 1273.30 |
| 000-14538-001 |  HALO24 Radar - A 24" powerful 25W Solid-State Radar, delivering 60RPM at short range and up to 48nm range. Identify hazards in an instant with VelocityTrack™ Doppler technology and can run dual scale to identify hazards long and far. | 2700.00 | 3213.00 |
| 000-13335-001 |  NAC-2 Autopilot Core Pack - Comes with NAC-2 Autopilot Computer, Precision-9 Compass and RF-25N Rudder Feedback unit. | 1620.83 | 1928.79 |
| 000-13337-001 |  NAC-2 VRF Autopilot Core Pack - Comes with NAC-2 Autopilot Computer and Precision-9 Compass. | 1354.17 | 1611.46 |
| 000-13336-001 |  NAC-3 Autopilot Core Pack - Comes with NAC-3 Autopilot Computer, Precision-9 Compass and RF-25N Rudder Feedback unit. | 2379.17 | 2831.21 |
| 000-13338-001 |  NAC-3 VRF Autopilot Core Pack - Comes with NAC-3 Autopilot Computer and Precision-9 Compass. | 2108.33 | 2508.92 |
| 000-10029-001 |  NEP-2 Network Expansion Port (Ethernetverteiler mit 5 Ports) | 309.00 | 367.71 |
| 000-0127-51 |  Ethernetkabel yellow 5 Pin 1.8 m (6 ft) | 38.00 | 45.22 |

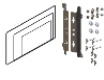
| Part Number | Description | RRP excl. (EUR) | RRP incl. (19.0%) |
|---------------|-------------------------------------------------------------------------------------------------------------------------------------------------------------------------------------------------------------------------------------------------------------------------|-----------------|-------------------|
| 000-0127-29 |  Ethernetkabel yellow 5 Pin 4.5 m (15 ft) | 56.00 | 66.64 |
| 000-0127-30 |  Ethernetkabel yellow 5 Pin 7.7 m (25 ft) | 79.00 | 94.01 |
| 000-0127-37 |  Ethernetkabel yellow 5 Pin 15.2 m (50 ft) | 109.00 | 129.71 |
| 000-11246-001 |  RJ45-Yellow Round Ethernet adapter cable RJ45 Male / 5 Pin Female 10 cm (6") | 24.00 | 28.56 |
| 000-11248-001 |  HDMI monitor video cable 3 m (9.8 ft) | 23.99 | 28.55 |
| 000-11249-001 |  HDMI monitor video cable 10 m (33 ft) | 56.09 | 66.75 |
| 24005729 |  SimNet to Micro-C (male) cable that connects a SimNet product to a NMEA 2000® backbone. 0.5 m (1.6 ft) | 38.00 | 45.22 |
| 000-14488-001 |  Missing Image Spacer required if using the Heavy Duty Gimbal bracket kit (000-13547-001) to mount an NSO16 evo3 or ZEUS3-16 display.(not required for 19 and 24 " displays) | 51.49 | 61.27 |
| 000-11247-001 |  NSOevo2, NSOevo3S, Zeus2 and Zeus3S NMEA0183 and Touch Monitor Serial Cable. 2m (6.5 ft) | 21.00 | 24.99 |
| 000-13892-001 |  MI10 Dashmount microSD card reader: Provides a dual Chart Card reader for use with NSO and Zeus MFD / MPU systems. | 219.00 | 260.61 |
| 000-11142-001 |  SonarHub Module, with power cable and Ethernet cable 4.5m (15ft). Requires adapter 000-12571-001 or 000-13977-001 adapter cable to use Airmar Non-Chirp or Chirp 9-pin transducers. | 648.00 | 771.12 |
| 000-12397-001 |  StructureScan® 3D module only. Transom mount and Through-Hull transducers available separately. | 648.00 | 771.12 |







Spare Parts

| Part Number | Description | RRP excl. (EUR) | RRP incl. (19.0%) |
|---------------|-------------------------------------------------------------------------------------------------------------------------------------------------------------------------------------|-----------------|-------------------|
| 000-11246-001 |  RJ45-Yellow Round Ethernet adapter cable RJ45 Male / 5 Pin Female 10 cm (6") | 24.00 | 28.56 |
| 000-14357-001 |  B&G Suncover for 16" Monitor | 92.70 | 110.31 |
| 000-14358-001 |  B&G Suncover for 19" Monitor | 108.15 | 128.70 |
| 000-11618-001 |  MO, NSO evo3 16/19/24.Rear mount bracket kit. Includes: dash seal for 16,19,24" and Bracket kit | 63.00 | 74.97 |









| Part Number | Description | RRP excl. (EUR) | RRP incl. (19.0%) |
|---------------|------------------------------------------------------------------------------------------------------------------------------------------------------------------------------------------------------|-----------------|-------------------|
| 000-11247-001 |  NSOevo2, NSOevo3S, Zeus2 and Zeus3S NMEA0183 and Touch Monitor Serial Cable. 2m (6.5 ft) | 21.00 | 24.99 |
| 000-13892-001 |  MI10 Dashmount microSD card reader: Provides a dual Chart Card reader for use with NSO and Zeus MFD / MPU systems. | 219.00 | 260.61 |
| 000-00128-001 |  4-pin Power Cable for modules and MFDs. | 40.00 | 47.60 |
| 000-11614-001 |  MO, NSO evo3 16/19/24 Cable retention bracket | 27.53 | 32.76 |

















Zeus³/³S











Main Products

| Part Number | Description | RRP excl. (EUR) | RRP incl. (19.0%) |
|---------------|--------------------------------------------------------------------------------------------------------------------------------------------------------------------------------------------------------------------------------------------------------------------------------------------------------------------------------------------------------------------------------------------------------------------------------------|-----------------|-------------------|
| 000-13245-001 |  B&G Zeus ³ -7 is an easy-to-use chartplotter navigation system for blue water cruisers and regatta racers, incorporating a 7-inch touchscreen display, high-performance electronics, and a wide range of functionality designed specifically for sailors. Includes World basemap chart. | 1620.00 | 1927.80 |
| 000-15411-001 |  B&G Zeus ³ S-9 is an easy-to-use chartplotter navigation system for blue water cruisers and regatta racers, incorporating a 9-inch touchscreen display, high-performance electronics, and a wide range of functionality designed specifically for sailors. world base map charts. | 2499.00 | 2973.81 |
| 000-15412-002 |  B&G Zeus ³ S-12 is an easy-to-use chartplotter navigation system for blue water cruisers and regatta racers, incorporating a 12-inch touchscreen display, high-performance electronics, and a wide range of functionality designed specifically for sailors. World basemap charts | 3899.00 | 4639.81 |
| 000-15413-001 |  B&G Zeus ³ S-16 is an easy-to-use chartplotter navigation system for blue water cruisers and regatta racers, incorporating a 16-inch touchscreen display, high-performance electronics, and a wide range of functionality designed specifically for sailors. World base map. | 6080.00 | 7235.20 |
| 000-15563-001 |  B&G Zeus ³ S-9 and Halo20+ Radar kit. The B&G Zeus ³ S-9 is an easy-to-use chartplotter navigation system for blue water cruisers and regatta racers, incorporating a 9-inch touchscreen display, high-performance electronics, and a wide range of functionality designed specifically for sailors. world base map charts. | 4418.10 | 5257.54 |
| 000-15564-002 |  B&G Zeus ³ S-12 and Halo20+ Radar kit. The B&G Zeus ³ S-12 is an easy-to-use chartplotter navigation system for blue water cruisers and regatta racers, incorporating a 12-inch touchscreen display, high-performance electronics, and a wide range of functionality designed specifically for sailors. World basemap charts | 5678.10 | 6756.94 |







Accessories













| Part Number | Description | RRP excl. (EUR) | RRP incl. (19.0%) |
|---------------|----------------------------------------------------------------------------------------------------------------------------------------------------------------------------------------------------------------------------------------------------------------------------------------------------------------------------------------------------------------------------|-----------------|-------------------|
| 000-12607-001 |  Precision-9 Compass - Outputs Heading, Rate Of Turn, Roll and Pitch over the NMEA 2000® network. | 669.00 | 796.11 |
| 000-13294-001 |  Triton ² Digital Display - Multi-purpose 4.1 inch colour sailing instrument and autopilot display. | 515.00 | 612.85 |
| 000-11674-001 |  ForwardScan TM Transducer Kit with Sleeve & Plug. 10m (33ft) Cable | 769.00 | 915.11 |
| 000-15793-001 |  B&G V100-B Blackbox VHF Radio System - featuring a built-in GPS and Class B AIS transceiver, which allows you to see and be seen by AIS-equipped vessels. Stay connected from anywhere on board with up to 8 handsets (4 wired and 4 wireless) and 4 external speakers. | 1574.00 | 1873.06 |
| 000-14380-001 |  The V3100 Class B AIS incorporates SOTDMA technology and increased transmission power to enhance transmission frequency, reliability, and range compared to standard Class B AIS. This 'black-box' solution integrates with MFD displays, and features industry-standard connectivity. | 935.00 | 1112.65 |
| 000-14492-001 |  B&G V20S Class D DSC VHF Radio - The versatile V20S is ideal for a variety of boats from small yachts to larger cruisers and racing boats, and is designed to match the low-profile style of our chartplotters and accessories. | 334.00 | 397.46 |
| 000-14382-001 |  WS310 Wired Wind Sensor with 20m (65.5ft) mast cable and interface for connection to the NMEA 2000® network. | 549.00 | 653.31 |
| 000-14471-001 |  B&G V60 fixed-mount DSC VHF Radio - Stay safe and connected with this VHF marine radio featuring a sleek design with removable fist mic, Class D DSC functionality, and built-in GPS. | 539.00 | 641.41 |
| 000-14843-001 |  WS310 Wired Wind Sensor with 35m (115ft) mast cable and interface for connection to the NMEA 2000® network. | 587.00 | 698.53 |

| Part Number | Description | RRP excl. (EUR) | RRP incl. (19.0%) |
|---------------|-------------------------------------------------------------------------------------------------------------------------------------------------------------------------------------------------------------------------------------------------------------------------------------------------------------------------------------------------------------------------------------------------------------------------------------------------------------------------------------------------------------------------------------------------------------------------------------------------------------------------|-----------------|-------------------|
| 000-13963-001 |  NAIS-500 Class B AIS including NSPL500 VHF/AIS Antenna splitter and GPS500 antenna. Broadcast your location to anyone nearby with an AIS Receiver. A low cost safety system for recreational vessels and smaller professional vessels in near coastal waters. | 1099.00 | 1307.81 |
| 000-15644-001 |  B&G V100 Blackbox VHF Radio System - Stay safer on the water with the B&G V100 VHF marine radio. With up to 8 connected handsets (4 wired and 4 wireless) and 4 external speakers, stay connected from anywhere on board. | 940.00 | 1118.60 |
| 000-14540-001 |  HALO20 Radar - A cost-effective compact 20" Radar dome. 24nm range and 24RPM. The perfect radar solution for budget-conscious sailors with smaller vessels. | 2050.00 | 2439.50 |
| 000-14474-001 |  B&G V60-B Marine VHF Radio - Stay safer on the water with this VHF marine radio featuring a built-in GPS and a full Class B AIS transmitter and receiver, which allows you to see and be seen by nearby AIS-equipped vessels. | 1049.00 | 1248.31 |
| 000-15876-001 |  The IP CAM-1 marine grade 316 stainless steel IP camera. Powered by 12V DC or PoE. | 559.00 | 665.21 |
| 000-15974-001 |  Sail Performance sensor pack. Includes WS320 wind pack, IDST-850 transducer, ZG100 GPS antenna, and Micro-C backbone kit and cables. | 1427.00 | 1698.13 |
| 000-15134-001 |  Triton™ Edge Sailing Processor with NMEA 2000®, Ethernet and built-in Wi-Fi. | 1510.00 | 1796.90 |
| 000-14539-001 |  HALO20+ Radar - A compact 20" powerful 25W Solid-State Radar, delivering 60RPM at short range and up to 36nm range. Identify hazards in an instant with VelocityTrack™ Doppler technology and can run dual scale to identify hazards long and far. | 2410.00 | 2867.90 |
| 000-14819-001 |  B&G V60-B Marine VHF Radio - Stay safer on the water with this VHF marine radio featuring a built-in GPS and a full Class B AIS transmitter and receiver, which allows you to see and be seen by nearby AIS-equipped vessels. Includes GPS-500 GPS antenna for situations where the internal GPS don't get reception. | 1149.00 | 1367.31 |
| 000-15648-001 |  B&G H100 wired handset and speaker for V100/V100-B VHF radios. Up to 4 wired handsets can be added to one system and 4 wired Speakers. | 373.00 | 443.87 |
| 000-14383-001 |  WS320 Wireless Wind Sensor including Wireless Interface for connection to NMEA 2000® networks. For masts up to 25m in height. | 659.00 | 784.21 |
| 000-11542-001 |  H5000 Graphic Display - A 5-inch colour display with a straightforward user interface packed with unique sailing features including SailSteer and Start Line. | 1070.00 | 1273.30 |
| 000-14538-001 |  HALO24 Radar - A 24" powerful 25W Solid-State Radar, delivering 60RPM at short range and up to 48nm range. Identify hazards in an instant with VelocityTrack™ Doppler technology and can run dual scale to identify hazards long and far. | 2700.00 | 3213.00 |
| 000-13335-001 |  NAC-2 Autopilot Core Pack - Comes with NAC-2 Autopilot Computer, Precision-9 Compass and RF-25N Rudder Feedback unit. | 1620.83 | 1928.79 |
| 000-13337-001 |  NAC-2 VRF Autopilot Core Pack - Comes with NAC-2 Autopilot Computer and Precision-9 Compass. | 1354.17 | 1611.46 |
| 000-13336-001 |  NAC-3 Autopilot Core Pack - Comes with NAC-3 Autopilot Computer, Precision-9 Compass and RF-25N Rudder Feedback unit. | 2379.17 | 2831.21 |
| 000-13338-001 |  NAC-3 VRF Autopilot Core Pack - Comes with NAC-3 Autopilot Computer and Precision-9 Compass. | 2108.33 | 2508.92 |

| Part Number | Description | RRP excl. (EUR) | RRP incl. (19.0%) |
|---------------|-------------------------------------------------------------------------------------------------------------------------------------------------------------------------------------------------------|-----------------|-------------------|
| 000-10029-001 |  NEP-2 Network Expansion Port (Ethernetverteiler mit 5 Ports) | 309.00 | 367.71 |
| 000-0127-51 |  Ethernetkabel yellow 5 Pin 1.8 m (6 ft) | 38.00 | 45.22 |
| 000-0127-29 |  Ethernetkabel yellow 5 Pin 4.5 m (15 ft) | 56.00 | 66.64 |
| 000-0127-30 |  Ethernetkabel yellow 5 Pin 7.7 m (25 ft) | 79.00 | 94.01 |
| 000-0127-37 |  Ethernetkabel yellow 5 Pin 15.2 m (50 ft) | 109.00 | 129.71 |
| 24005729 |  SimNet to Micro-C (male) cable that connects a SimNet product to a NMEA 2000® backbone. 0.5 m (1.6 ft) | 38.00 | 45.22 |
| 000-00129-001 |  Video/Data Cable - Provides 2x Analog Composite Video Inputs (RCA Female) and a NMEA 0183 Interface. | 28.00 | 33.32 |
| 000-12742-001 |  HDMI Cable with vibration resistant and waterproof connector on one end to connect to Navico MFDs with HDMI port. | 54.00 | 64.26 |
| 000-12741-001 |  HDMI Cable with vibration resistant and waterproof connector on one end to connect to Navico MFDs with HDMI port. | 87.00 | 103.53 |
| 000-12397-001 |  StructureScan® 3D module only. Transom mount and Through-Hull transducers available separately. | 648.00 | 771.12 |



Spare Parts

| Part Number | Description | RRP excl. (EUR) | RRP incl. (19.0%) |
|---------------|---------------------------------------------------------------------------------------------------------------------------------|-----------------|-------------------|
| 000-13744-001 |  B&G Zeus ³ 7" Sun cover | 26.00 | 30.94 |
| 000-13745-001 |  B&G Zeus ³ /S 9" Sun cover | 29.00 | 34.51 |
| 000-13746-001 |  B&G Zeus ³ /S 12" Sun cover | 32.00 | 38.08 |
| 000-13747-001 |  B&G Zeus ³ /S 16" Sun cover | 35.00 | 41.65 |
| 000-13748-001 |  NSSevo3 & ZEUS ³ Chart Card Door | 14.00 | 16.66 |
| 000-13749-001 |  NSSevo3 & ZEUS ³ 7" Edge Bezels | 16.00 | 19.04 |













| Part Number | Description | RRP excl. (EUR) | RRP incl. (19.0%) |
|---------------|--------------------------------------------------------------------------------------------------------------------------------------------------------------------------------------|-----------------|-------------------|
| 000-13750-001 |  NSSevo3/3S & ZEUS ³ / ³ S 9" Edge Bezels | 18.00 | 21.42 |
| 000-13751-001 |  NSSevo3/3S & ZEUS ³ / ³ S 12" Edge Bezels | 20.00 | 23.80 |
| 000-13752-001 |  NSSevo3/3S & ZEUS ³ / ³ S 16" Edge Bezels | 25.00 | 29.75 |
| 000-13753-001 |  NSSevo3 & ZEUS ³ 7" Dash Mount Kit | 20.00 | 23.80 |
| 000-13754-001 |  NSSevo3/3S & ZEUS ³ / ³ S 9" Dash Mount Kit | 23.00 | 27.37 |
| 000-13755-001 |  NSSevo3/3S & ZEUS ³ / ³ S 12" Dash Mount Kit | 27.00 | 32.13 |
| 000-13756-001 |  NSSevo3/3S & ZEUS ³ / ³ S 16" Dash Mount Kit | 36.00 | 42.84 |
| 000-13758-001 |  NSSevo3/3S & ZEUS ³ / ³ S 9" Mounting Bracket (Plastic) | 36.00 | 42.84 |
| 000-13759-001 |  NSSevo3/3S & ZEUS ³ / ³ S 12" Mounting Bracket | 66.00 | 78.54 |
| 000-14317-001 |  Replacement Rotary knob for Simrad NSS evo3 & Zeus ³ MFDs | 22.00 | 26.18 |
| 000-13702-001 |  Gimbal mounting bracket for Simrad NSX 3009, GO9, NSS7 evo3,, and B&G Vulcan9, Zeus3 7 (Plastic) | 33.00 | 39.27 |
| 000-00128-001 |  4-pin Power Cable for modules and MFDs. | 40.00 | 47.60 |
| 000-10467-001 |  NSS Kartenschachtklappe | 15.00 | 17.85 |













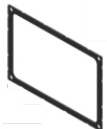

Vulcan

Main Products









| Part Number | Description | RRP excl. (EUR) | RRP incl. (19.0%) |
|---------------|----------------------------------------------------------------------------------------------------------------------------------------------------------------------------------------------------------------------------------------------------------------------------------------------------------------------------------------------|-----------------|-------------------|
| 000-14082-001 |  B&G Vulcan 7R 7-inch chartplotter and radar display with global basemap | 630.00 | 749.70 |
| 000-13214-001 |  B&G Vulcan 9 FS: 9" Multifunction display. Super high-bright multi touch screen with built in NMEA 2000, GPS, Wi-Fi and ForwardScan (optional transducer required). Integrates to 3G/4G or Halo20/20+ radars. No transducer included. Global basemap chart | 900.00 | 1071.00 |
| 000-15620-001 |  B&G Vulcan9 FS and Halo20 radar bundle. Global base map chart | 2832.00 | 3370.08 |

Accessories

| Part Number | Description | RRP excl. (EUR) | RRP incl. (19.0%) |
|---------------|-----------------------------------------------------------------------------------------------------------------------------------------------------------------------------------------------------------------------------------------------------------------------------------------------------------------------------------------------------------|-----------------|-------------------|
| 000-15793-001 |  B&G V100-B Blackbox VHF Radio System - featuring a built-in GPS and Class B AIS transceiver, which allows you to see and be seen by AIS-equipped vessels. Stay connected from anywhere on board with up to 8 handsets (4 wired and 4 wireless) and 4 external speakers. | 1574.00 | 1873.06 |
| 000-14382-001 |  WS310 Wired Wind Sensor with 20m (65.5ft) mast cable and interface for connection to the NMEA 2000® network. | 549.00 | 653.31 |
| 000-12607-001 |  Precision-9 Compass - Outputs Heading, Rate Of Turn, Roll and Pitch over the NMEA 2000® network. | 669.00 | 796.11 |
| 000-11674-001 |  ForwardScan™ Transducer Kit with Sleeve & Plug. 10m (33ft) Cable | 769.00 | 915.11 |
| 000-11518-001 |  Fluid Level Sensor - Connects to a standard suitable tank level sensor and transmits the tank level on the the NMEA 2000 network. | 109.00 | 129.71 |
| 000-13284-001 |  ForwardScan™ Transducer Kit (Long-Stem) with Sleeve & Plug. 10m (33ft) Cable | 1079.17 | 1284.21 |
| 000-13296-001 |  Triton² Pilot Controller. This intuitive keypad can be combined with a B&G Triton² Display to create a fully-featured autopilot controller. | 345.00 | 410.55 |
| 000-15644-001 |  B&G V100 Blackbox VHF Radio System - Stay safer on the water with the B&G V100 VHF marine radio. With up to 8 connected handsets (4 wired and 4 wireless) and 4 external speakers, stay connected from anywhere on board. | 940.00 | 1118.60 |
| 000-15974-001 |  Sail Performance sensor pack. Includes WS320 wind pack, IDST-850 transducer, ZG100 GPS antenna, and Micro-C backbone kit and cables. | 1427.00 | 1698.13 |
| 000-15134-001 |  Triton™ Edge Sailing Processor with NMEA 2000®, Ethernet and built-in Wi-Fi. | 1510.00 | 1796.90 |
| 000-14383-001 |  WS320 Wireless Wind Sensor including Wireless Interface for connection to NMEA 2000® networks. For masts up to 25m in height. | 659.00 | 784.21 |
| 000-11520-001 |  Temperature Sensor - Can be mounted anywhere you want to monitor the temperature. Can be configured to output a variety of different temperature types. | 119.00 | 141.61 |



| Part Number | Description | RRP excl. (EUR) | RRP incl. (19.0%) |
|---------------|------------------------------------------------------------------------------------------------------------------------------------------------------------------------------------------------------------------------------------------------------------------------------------------------------------------------|-----------------|-------------------|
| 000-11738-001 |  DT800 Depth/Temp Sensor. Plastic thru-hull housing. | 349.00 | 415.31 |
| 000-11521-001 |  Through-Hull Temperature Sensor - Mount through the hull of the vessel or wall of a tank you want to monitor the temperature inside. Can be configured to output a variety of different temperature types. | 108.90 | 129.59 |
| 000-11852-001 |  Airmar IDST800L 235F B-122-RETR 6M | 658.90 | 784.09 |
| 000-12374-001 |  Flush mount O'ring type seal for use with the Flush mount kit for GO7 & Vulcan 7 displays. | 22.00 | 26.18 |
| 22098586 |  ST850 passive S/T sensor TH plastic with 1 m (7 ft) Pigtail (Connects speed to D800 (22098560)) | 117.00 | 139.23 |
| 000-12373-001 |  Replacement panel / dashboard gasket for GO7 & Vulcan 7 displays | 11.00 | 13.09 |
| 000-12365-001 |  B&G ZC2 Remote controller. (Portrait mount). For use with ZEUS ^{2/3} , ZEUS ^{2/3} Glass Helm and Vulcan MFD systems and brings simple and precise MFD control in even the roughest sea conditions. | 440.00 | 523.60 |
| 000-13335-001 |  NAC-2 Autopilot Core Pack - Comes with NAC-2 Autopilot Computer, Precision-9 Compass and RF-25N Rudder Feedback unit. | 1620.83 | 1928.79 |
| 000-13337-001 |  NAC-2 VRF Autopilot Core Pack - Comes with NAC-2 Autopilot Computer and Precision-9 Compass. | 1354.17 | 1611.46 |
| 000-12513-001 |  B&G ZC2 Remote controller. (Landscape mount) For use with ZEUS ^{2/3} , ZEUS ^{2/3} Glass Helm and Vulcan MFD systems and brings simple and precise MFD control in even the roughest sea conditions.. | 490.00 | 583.10 |
| 000-12366-001 |  FLUSH MOUNT KIT, GO7 & VULCAN 7 Note: If flush mounting the Go7 or Vulcan 7 you may need the specific sun cover for the flush mount installation method. For GO7 please order 000-12368-001 or for Vulcan order 000-12370-001). | 30.59 | 36.40 |
| 000-13336-001 |  NAC-3 Autopilot Core Pack - Comes with NAC-3 Autopilot Computer, Precision-9 Compass and RF-25N Rudder Feedback unit. | 2379.17 | 2831.21 |
| 000-13338-001 |  NAC-3 VRF Autopilot Core Pack - Comes with NAC-3 Autopilot Computer and Precision-9 Compass. | 2108.33 | 2508.92 |
| 000-13714-001 |  Networked wind sensor for Triton2, Triton, IS42, IS40 and IS20 systems. Sensor only, does not include cable. | 430.00 | 511.70 |
| 000-13703-001 |  Auto-Stby Button - Metal. For a physical Auto/Stby button in systems with NAC-1 and NAC-2 Autopilot Computers. | 48.00 | 57.12 |
| 000-12370-001 | SUNCOVER, VULCAN 7 FLUSH MOUNT | 22.66 | 26.97 |

Spare Parts













| Part Number | Description | RRP excl. (EUR) | RRP incl. (19.0%) |
|---------------|--------------------------------------------------------------------------------------------------------------------------------------------------------|-----------------|-------------------|
| 000-13172-001 |  Vulcan-5 Suncover | 14.99 | 17.84 |
| 000-13171-001 |  GO5 & Vulcan-5 Power & N2K Cable | 38.00 | 45.22 |
| 000-10027-001 |  Quick Release Bracket - GO5 / Vulcan5 / P2005 / I3005 / Mark / Elite | 26.99 | 32.12 |
| 000-13170-001 |  Edge Bezel for P2005, I3005, GO5 & Vulcan-5 | 11.00 | 13.09 |
| 000-13169-001 |  Dash Mount kit for P2005, I3005, GO5 & Vulcan-5 | 14.00 | 16.66 |
| 000-13700-001 |  Replacement bezel for Simrad GO9 or B&G Vulcan9. | 18.00 | 21.42 |
| 000-14148-001 |  U-BRACKET 12" GO, VULCAN, NSX, ZEUS S | 33.00 | 39.27 |
| 000-00128-001 |  4-pin Power Cable for modules and MFDs. | 40.00 | 47.60 |

















Zeus S



Main Products

| Part Number | Description | RRP excl. (EUR) | RRP incl. (19.0%) |
|---------------|-----------------------------------------------------------------------------------------------------------------------------------------------------------------------------------------------------------------------------------------------------------------------------------------------------------------------------------------|-----------------|-------------------|
| 000-15217-001 |  B&G Zeus S 7 Chartplotter GLOBAL. 7-inch SolarMAX™ high definition display. Built-in GPS, and WIFI, 1 kW echosounder. Unique Sailing Modes and enhanced sailing features. A next-generation C-MAP® DISCOVER™ X or REVEAL X™ chart card is required. | 840.00 | 999.60 |
| 000-15221-001 |  B&G Zeus S 9 Chartplotter GLOBAL. 9-inch SolarMAX™ high definition display. Built-in GPS, and WIFI, 1 kW echosounder. Unique Sailing Modes and enhanced sailing features. A next-generation C-MAP® DISCOVER™ X or REVEAL X™ chart card is required. | 1430.00 | 1701.70 |
| 000-15225-001 |  B&G Zeus S 12 Chartplotter GLOBAL. 12-inch SolarMAX™ high definition display. Built-in GPS, and WIFI, 1 kW echosounder. Unique Sailing Modes and enhanced sailing features. A next-generation C-MAP® DISCOVER™ X or REVEAL X™ chart card is required. | 2520.00 | 2998.80 |









Accessories

| Part Number | Description | RRP excl. (EUR) | RRP incl. (19.0%) |
|---------------|-----------------------------------------------------------------------------------------------------------------------------------------------------------------------------------------------------------------------------------------------------------------------------------------------------------------------------------------------------------|-----------------|-------------------|
| 000-15611-001 |  B&G Nemesis™ 9" Sailing Display. The Ultimate sailing display providing visibility & versatility, complete customization and total integration. | 1999.00 | 2378.81 |
| 000-15793-001 |  B&G V100-B Blackbox VHF Radio System - featuring a built-in GPS and Class B AIS transceiver, which allows you to see and be seen by AIS-equipped vessels. Stay connected from anywhere on board with up to 8 handsets (4 wired and 4 wireless) and 4 external speakers. | 1574.00 | 1873.06 |
| 000-14492-001 |  B&G V20S Class D DSC VHF Radio - The versatile V20S is ideal for a variety of boats from small yachts to larger cruisers and racing boats, and is designed to match the low-profile style of our chartplotters and accessories. | 334.00 | 397.46 |
| 000-14382-001 |  WS310 Wired Wind Sensor with 20m (65.5ft) mast cable and interface for connection to the NMEA 2000® network. | 549.00 | 653.31 |
| 000-14471-001 |  B&G V60 fixed-mount DSC VHF Radio - Stay safe and connected with this VHF marine radio featuring a sleek design with removable fist mic, Class D DSC functionality, and built-in GPS. | 539.00 | 641.41 |
| 000-13294-001 |  Triton² Digital Display - Multi-purpose 4.1 inch colour sailing instrument and autopilot display. | 515.00 | 612.85 |
| 000-12607-001 |  Precision-9 Compass - Outputs Heading, Rate Of Turn, Roll and Pitch over the NMEA 2000® network. | 669.00 | 796.11 |
| 000-14843-001 |  WS310 Wired Wind Sensor with 35m (115ft) mast cable and interface for connection to the NMEA 2000® network. | 587.00 | 698.53 |
| 000-13963-001 |  NAIS-500 Class B AIS including NSPL500 VHF/AIS Antenna splitter and GPS500 antenna. Broadcast your location to anyone nearby with an AIS Receiver. A low cost safety system for recreational vessels and smaller professional vessels in near coastal waters. | 1099.00 | 1307.81 |
| 000-15644-001 |  B&G V100 Blackbox VHF Radio System - Stay safer on the water with the B&G V100 VHF marine radio. With up to 8 connected handsets (4 wired and 4 wireless) and 4 external speakers, stay connected from anywhere on board. | 940.00 | 1118.60 |
| 000-14540-001 |  HALO20 Radar - A cost-effective compact 20" Radar dome. 24nm range and 24RPM. The perfect radar solution for budget-conscious sailors with smaller vessels. | 2050.00 | 2439.50 |
| 000-14474-001 |  B&G V60-B Marine VHF Radio - Stay safer on the water with this VHF marine radio featuring a built-in GPS and a full Class B AIS transmitter and receiver, which allows you to see and be seen by nearby AIS-equipped vessels. | 1049.00 | 1248.31 |

| Part Number | Description | RRP excl. (EUR) | RRP incl. (19.0%) |
|---------------|----------------------------------------------------------------------------------------------------------------------------------------------------------------------------------------------------------------------------------------------------------------------------------------------------------------------------------------------------------------------------------------------------------|-----------------|-------------------|
| 000-15612-001 |  B&G Nemesis™ 12" Sailing Display. The Ultimate sailing display providing visibility & versatility, complete customization and total integration. | 2999.00 | 3568.81 |
| 000-15876-001 |  The IP CAM-1 marine grade 316 stainless steel IP camera. Powered by 12V DC or PoE. | 559.00 | 665.21 |
| 000-15974-001 |  Sail Performance sensor pack. Includes WS320 wind pack, IDST-850 transducer, ZG100 GPS antenna, and Micro-C backbone kit and cables. | 1427.00 | 1698.13 |
| 000-15134-001 |  Triton™ Edge Sailing Processor with NMEA 2000®, Ethernet and built-in Wi-Fi. | 1510.00 | 1796.90 |
| 000-15683-001 |  B&G Nemesis™ Hub allows compact and straightforward connection of up to 3 Nemesis™ displays at a key location (mast, helm etc) with a single Power/Ethernet cable run, and a simple interconnect cable from the hub to each display. | 375.00 | 446.25 |
| 000-14539-001 |  HALO20+ Radar - A compact 20" powerful 25W Solid-State Radar, delivering 60RPM at short range and up to 36nm range. Identify hazards in an instant with VelocityTrack™ Doppler technology and can run dual scale to identify hazards long and far. | 2410.00 | 2867.90 |
| 000-14819-001 |  B&G V60-B Marine VHF Radio - Stay safer on the water with this VHF marine radio featuring a built-in GPS and a full Class B AIS transmitter and receiver, which allows you to see and be seen by nearby AIS-equipped vessels. Includes GPS-500 GPS antenna for situations where the internal GPS don't get reception. | 1149.00 | 1367.31 |
| 000-15648-001 |  B&G H100 wired handset and speaker for V100/V100-B VHF radios. Up to 4 wired handsets can be added to one system and 4 wired Speakers. | 373.00 | 443.87 |
| 000-14383-001 |  WS320 Wireless Wind Sensor including Wireless Interface for connection to NMEA 2000® networks. For masts up to 25m in height. | 659.00 | 784.21 |
| 000-14538-001 |  HALO24 Radar - A 24" powerful 25W Solid-State Radar, delivering 60RPM at short range and up to 48nm range. Identify hazards in an instant with VelocityTrack™ Doppler technology and can run dual scale to identify hazards long and far. | 2700.00 | 3213.00 |
| 000-13335-001 |  NAC-2 Autopilot Core Pack - Comes with NAC-2 Autopilot Computer, Precision-9 Compass and RF-25N Rudder Feedback unit. | 1620.83 | 1928.79 |
| 000-13337-001 |  NAC-2 VRF Autopilot Core Pack - Comes with NAC-2 Autopilot Computer and Precision-9 Compass. | 1354.17 | 1611.46 |
| 000-13336-001 |  NAC-3 Autopilot Core Pack - Comes with NAC-3 Autopilot Computer, Precision-9 Compass and RF-25N Rudder Feedback unit. | 2379.17 | 2831.21 |
| 000-13338-001 |  NAC-3 VRF Autopilot Core Pack - Comes with NAC-3 Autopilot Computer and Precision-9 Compass. | 2108.33 | 2508.92 |
| 000-10029-001 |  NEP-2 Network Expansion Port (Ethernetverteiler mit 5 Ports) | 309.00 | 367.71 |
| 000-0127-51 |  Ethernetkabel yellow 5 Pin 1.8 m (6 ft) | 38.00 | 45.22 |



| Part Number | Description | RRP excl. (EUR) | RRP incl. (19.0%) |
|-------------|-----------------------------------------------------------------------------------------------------------------------------|-----------------|-------------------|
| 000-0127-29 |  Ethernetkabel yellow 5 Pin 4.5 m (15 ft) | 56.00 | 66.64 |
| 000-0127-30 |  Ethernetkabel yellow 5 Pin 7.7 m (25 ft) | 79.00 | 94.01 |
| 000-0127-37 |  Ethernetkabel yellow 5 Pin 15.2 m (50 ft) | 109.00 | 129.71 |

Spare Parts











| Part Number | Description | RRP excl. (EUR) | RRP incl. (19.0%) |
|---------------|--------------------------------------------------------------------------------------------------------------------------------------------------------------------------------------|-----------------|-------------------|
| 000-15822-001 |  Corner bezel clips for NSX range of displays. Set of four corner clips | 24.99 | 29.74 |
| 000-12372-001 |  Mounting bracket for Simrad NSX 3007, GO7 XSR, I3007, P3007, and B&G Vulcan 7R, | 29.00 | 34.51 |
| 000-15819-001 |  B&G Zeus S 7 Suncover | 29.99 | 35.69 |
| 000-15820-001 |  B&G Zeus S 9 Suncover | 29.99 | 35.69 |
| 000-15821-001 |  B&G Zeus S 12 Suncover | 34.99 | 41.64 |
| 000-13702-001 |  Gimbal mounting bracket for Simrad NSX 3009, GO9, NSS7 evo3., and B&G Vulcan9, Zeus3 7 (Plastic) | 33.00 | 39.27 |
| 000-14148-001 |  U-BRACKET 12" GO, VULCAN, NSX, ZEUS S | 33.00 | 39.27 |
| 000-00128-001 |  4-pin Power Cable for modules and MFDs. | 40.00 | 47.60 |

Nemesis

Main Products



| Part Number | Description | RRP excl. (EUR) | RRP incl. (19.0%) |
|---------------|------------------------------------------------------------------------------------------------------------------------------------------------------------------------------------------------------------------------------------------------------------------------------------------------------------------------|-----------------|-------------------|
| 000-15611-001 |  B&G Nemesis™ 9" Sailing Display. The Ultimate sailing display providing visibility & versatility, complete customization and total integration. | 1999.00 | 2378.81 |
| 000-15612-001 |  B&G Nemesis™ 12" Sailing Display. The Ultimate sailing display providing visibility & versatility, complete customization and total integration. | 2999.00 | 3568.81 |
| 000-15683-001 |  B&G Nemesis™ Hub allows compact and straightforward connection of up to 3 Nemesis™ displays at a key location (mast, helm etc) with a single Power/Ethernet cable run, and a simple interconnect cable from the hub to each display. | 375.00 | 446.25 |

Accessories

| Part Number | Description | RRP excl. (EUR) | RRP incl. (19.0%) |
|---------------|-------------------------------------------------------------------------------------------------------------------------------------------------------------------------------------------------------------------------------------------------------------------------------------------------------------------------|-----------------|-------------------|
| 000-15134-001 |  Triton™ Edge Sailing Processor with NMEA 2000®, Ethernet and built-in Wi-Fi. | 1510.00 | 1796.90 |
| 000-15683-001 |  B&G Nemesis™ Hub allows compact and straightforward connection of up to 3 Nemesis™ displays at a key location (mast, helm etc) with a single Power/Ethernet cable run, and a simple interconnect cable from the hub to each display. | 375.00 | 446.25 |
| 000-15893-001 |  B&G Nemesis™ 9 Mast Bracket | 280.00 | 333.20 |
| 000-15894-001 |  B&G Nemesis™ 12 Mast Bracket | 325.00 | 386.75 |
| 000-14547-001 |  Power / Ethernet cable, 5 m (16.5 ft) for HALO dome radars and B&G Nemesis displays | 77.00 | 91.63 |
| 000-14548-001 |  Power / Ethernet cable, 10 m (33 ft) for HALO dome radars and B&G Nemesis displays | 119.00 | 141.61 |
| 000-14549-001 |  Power / Ethernet cable, 20 m (65.5 ft) for HALO dome radars and B&G Nemesis displays | 179.00 | 213.01 |
| 000-14550-001 |  Power / Ethernet cable, 30 m (98.5 ft) for HALO dome radars and B&G Nemesis displays | 239.00 | 284.41 |
| 000-15739-001 |  NMEA 2000 cable 0.6 m (2 ft) Micro-C straight connector / 90 degree female connector. | 34.00 | 40.46 |
| 000-15740-001 |  Nemesis™ Power & Ethernet Hub Interconnect cable. 60cm (2 ft). One required per display to be connected to the Hub. | 69.00 | 82.11 |



Spare Parts

| Part Number | Description | RRP excl. (EUR) | RRP incl. (19.0%) |
|---------------|------------------------------------------------------------------------------------------------------------------------------------------------------------|-----------------|-------------------|
| 000-15822-001 |  Corner bezel clips for NSX range of displays. Set of four corner clips | 24.99 | 29.74 |















| Part Number | Description | RRP excl. (EUR) | RRP incl. (19.0%) |
|---------------|------------------------------------------------------------------------------------------------------------------|--------------------|----------------------|
| 000-15868-001 |  B&G Nemesis™ 9 Spare Suncover | 31.60 | 37.60 |
| 000-15869-001 |  B&G Nemesis™ 12 Spare Suncover | 34.50 | 41.06 |

Triton™ Edge



Main Products

| Part Number | Description | RRP excl. (EUR) | RRP incl. (19.0%) |
|---------------|------------------------------------------------------------------------------------------------------------------------------------------------------------------------------------------------------------------------------|-----------------|-------------------|
| 000-11548-002 |  Triton™ Edge Sailing Processor Base Pack, Comes with Triton™ Edge Sailing Processor, Triton2 Instrument display, and Micro-C Backbone kit. | 1903.50 | 2265.17 |
| 000-15134-001 |  Triton™ Edge Sailing Processor with NMEA 2000®, Ethernet and built-in Wi-Fi. | 1510.00 | 1796.90 |

Accessories





| Part Number | Description | RRP excl. (EUR) | RRP incl. (19.0%) |
|---------------|------------------------------------------------------------------------------------------------------------------------------------------------------------------------------------------------------------------------------------|-----------------|-------------------|
| 000-15611-001 |  B&G Nemesis™ 9" Sailing Display. The Ultimate sailing display providing visibility & versatility, complete customization and total integration. | 1999.00 | 2378.81 |
| 000-13294-001 |  Triton² Digital Display - Multi-purpose 4.1 inch colour sailing instrument and autopilot display. | 515.00 | 612.85 |
| 000-15612-001 |  B&G Nemesis™ 12" Sailing Display. The Ultimate sailing display providing visibility & versatility, complete customization and total integration. | 2999.00 | 3568.81 |
| 000-0119-79 |  N2K-T-RD - NMEA 2000® T-connector zur Netzwerkerweiterung | 22.00 | 26.18 |
| 000-12612-001 |  Low loss NMEA2000 4-way joiner. Connect four NMEA2000 Micro-C devices to the NMEA2000 Network. | 54.00 | 64.26 |
| 000-0119-88 |  N2KEXT-2RD - 0.61 m (2-ft) NMEA 2000® Netzwerkkabel | 32.00 | 38.08 |
| 000-0127-53 |  N2KEXT-6RD - 1.82 m (6-ft) NMEA 2000® Netzwerkkabel | 50.00 | 59.50 |
| 000-0119-86 |  N2KEXT-15RD - 4.55 m (15-ft) NMEA 2000® Netzwerkkabel | 56.00 | 66.64 |
| 000-0119-83 |  N2KEXT-25RD - 7.58 m (25-ft) NMEA 2000® Netzwerkkabel | 79.00 | 94.01 |
| 000-0127-51 |  Ethernetkabel yellow 5 Pin 1.8 m (6 ft) | 38.00 | 45.22 |
| 000-0127-29 |  Ethernetkabel yellow 5 Pin 4.5 m (15 ft) | 56.00 | 66.64 |
| 000-0127-30 |  Ethernetkabel yellow 5 Pin 7.7 m (25 ft) | 79.00 | 94.01 |
| 000-0127-37 |  Ethernetkabel yellow 5 Pin 15.2 m (50 ft) | 109.00 | 129.71 |
| 000-11246-001 |  RJ45-Yellow Round Ethernet adapter cable RJ45 Male / 5 Pin Female 10 cm (6") | 24.00 | 28.56 |

Spare Parts









| Part Number | Description | RRP excl. (EUR) | RRP incl. (19.0%) |
|---------------|--------------------------------------------------------------------------------------------------------------------------------------------------------------------------------------------------------------------------------------------------|-----------------|-------------------|
| 000-10760-001 |  <p>NMEA 2000 Micro-C Auto pilot network starter kit: Includes Network power cable, 4.5 m (15 ft) N2K cable, 3 x T-connectors, and 2 x network terminators.</p> | 90.00 | 107.10 |
| 000-13294-001 |  <p>Triton² Digital Display - Multi-purpose 4.1 inch colour sailing instrument and autopilot display.</p> | 515.00 | 612.85 |
| 000-15134-001 |  <p>Triton™ Edge Sailing Processor with NMEA 2000®, Ethernet and built-in Wi-Fi.</p> | 1510.00 | 1796.90 |

Triton²



Main Products

| Part Number | Description | RRP excl. (EUR) | RRP incl. (19.0%) |
|---------------|-----------------------------------------------------------------------------------------------------------------------------------------------------------------------------------------------------------------------------------------------------------------------------------------------------------------|-----------------|-------------------|
| 000-13294-001 |  Triton ² Digital Display - Multi-purpose 4.1 inch colour sailing instrument and autopilot display. | 515.00 | 612.85 |
| 000-14955-002 |  Triton ² Speed / Depth / Wind Instrument pack. Includes Triton ² Instrument Display, DST810 Depth/Speed/Temperature sensor, WS310 Wired Wind Sensor and a NMEA 2000® starter kit. | 1410.00 | 1677.90 |
| 000-14956-002 |  Triton ² Speed / Depth / Wireless Wind Instrument pack. Includes Triton ² Instrument Display, DST810 Depth/Speed/Temperature transducer, WS320 Wireless Wind Sensor and a NMEA2000 starter kit. | 1499.00 | 1783.81 |
| 000-14957-002 |  Dual Triton ² Speed / Depth / Wireless Wind Instrument pack. Includes 2x Triton ² Instrument Display, DST810 Depth/Speed/Temperature transducer, WS320 Wireless Wind Sensor and a NMEA2000 starter kit. | 2028.00 | 2413.32 |
| 000-13298-002 |  Triton ² Speed / Depth instrument pack. Pack includes Triton ² Instrument Display, DST810 Depth/Speed/Temperature transducer and a NMEA2000 starter kit. | 1007.00 | 1198.33 |

Accessories



| Part Number | Description | RRP excl. (EUR) | RRP incl. (19.0%) |
|---------------|---------------------------------------------------------------------------------------------------------------------------------------------------------------------------------------------------------------------------------------------------------------------------------------------------------|-----------------|-------------------|
| 000-12607-001 |  Precision-9 Compass - Outputs Heading, Rate Of Turn, Roll and Pitch over the NMEA 2000® network. | 669.00 | 796.11 |
| 000-14382-001 |  WS310 Wired Wind Sensor with 20m (65.5ft) mast cable and interface for connection to the NMEA 2000® network. | 549.00 | 653.31 |
| 000-13296-001 |  Triton ² Pilot Controller. This intuitive keypad can be combined with a B&G Triton ² Display to create a fully-featured autopilot controller. | 345.00 | 410.55 |
| 000-15134-001 |  Triton™ Edge Sailing Processor with NMEA 2000®, Ethernet and built-in Wi-Fi. | 1510.00 | 1796.90 |
| 000-15974-001 |  Sail Performance sensor pack. Includes WS320 wind pack, IDST-850 transducer, ZG100 GPS antenna, and Micro-C backbone kit and cables. | 1427.00 | 1698.13 |
| 000-14383-001 |  WS320 Wireless Wind Sensor including Wireless Interface for connection to NMEA 2000® networks. For masts up to 25m in height. | 659.00 | 784.21 |
| 000-13249-001 |  The low-current NAC-2 autopilot computer is ideal for smaller vessels, designed to run small hydraulic drives and mechanical drives for vessels up to 10 metres (33 feet) in length. Also provides solenoid output. | 939.00 | 1117.41 |
| 000-13250-001 |  The high-current NAC-3 autopilot computer is designed for vessels over 10 metres (33 feet) in length, with the ability to run heavy-duty hydraulic drive pumps & linear rams, and also provides solenoid output. | 1649.00 | 1962.31 |
| 000-10614-001 |  N2K, IS40 CABLE, MICRO-C, RIGHT ANGLE INTERCONNECT 0.4m (1.3 ft) | 24.00 | 28.56 |

Spare Parts

| Part Number | Description | RRP excl. (EUR) | RRP incl. (19.0%) |
|---------------|-----------------------------------------------------------------------------------------------------------------------------------------------------------------|--------------------|----------------------|
| 000-13722-001 |  Suncover for B&G Triton ² Display | 15.00 | 17.85 |
| 000-13950-001 |  IS42 & Triton2 Installation Kit - Includes edge bezel, screws and guide tool. | 14.00 | 16.66 |

Hercules



Main Products

| Part Number | Description | RRP excl. (EUR) | RRP incl. (19.0%) |
|---------------|------------------------------------------------------------------------------------------------------------------------------------------------------------------------------------------------------------------------------------|-----------------|-------------------|
| 000-11549-002 |  B&G Hercules® Sailing Processor Base Pack. Comes with Hercules® Sailing Processor, H5000 Graphic 5 inch colour display and Micro_C backbone kit. | 3537.00 | 4209.03 |
| 000-15135-001 |  B&G Hercules Sailing Processor | 2770.00 | 3296.30 |
| 000-15137-001 |  HERCULES EXPANSION MODULE | 1595.00 | 1898.05 |

Accessories







| Part Number | Description | RRP excl. (EUR) | RRP incl. (19.0%) |
|---------------|-------------------------------------------------------------------------------------------------------------|-----------------|-------------------|
| 000-15137-001 |  HERCULES EXPANSION MODULE | 1595.00 | 1898.05 |

Spare Parts









| Part Number | Description | RRP excl. (EUR) | RRP incl. (19.0%) |
|---------------|---------------------------------------------------------------------------------------------------------------------------------------------------------------------------------------------------------------------------------------------------|-----------------|-------------------|
| 000-10760-001 |  NMEA 2000 Micro-C Auto pilot network starter kit: Includes Network power cable, 4.5 m (15 ft) N2K cable, 3 x T-connectors, and 2 x network terminators. | 90.00 | 107.10 |
| 000-15135-001 |  B&G Hercules Sailing Processor | 2770.00 | 3296.30 |
| 000-11542-001 |  H5000 Graphic Display - A 5-inch colour display with a straightforward user interface packed with unique sailing features including SailSteer and Start Line. | 1070.00 | 1273.30 |



H5000

Main Products



| Part Number | Description | RRP excl. (EUR) | RRP incl. (19.0%) |
|---------------|------------------------------------------------------------------------------------------------------------------------------------------------------------------------------------------------------------------------------------------------------------------------------------------------------------------------------------------------------------|-----------------|-------------------|
| 000-11542-001 |  H5000 Graphic Display - A 5-inch colour display with a straightforward user interface packed with unique sailing features including SailSteer and Start Line. | 1070.00 | 1273.30 |
| 000-11725-001 |  Allows expansion of an H5000 system to include additional analogue and pulse signals from compatible 3rd party sensors. H5000 provides options for these inputs to be assigned to a known function type or to be set up as a custom input with name defined by the user. | 855.00 | 1017.45 |
| 000-11726-001 |  H5000 Serial Expansion allows expansion of an H5000 system. Provides additional serial interfacing options. Typically used for interfacing B&G HGSC heading sensor, GPS sensors, 3rd party heading sensors and other NMEA 0183 devices. | 855.00 | 1017.45 |
| 000-11551-001 |  H5000 3D Motion Sensor Enables Motion Correction for Wind data on H5000 Hercules/Performance systems | 980.00 | 1166.20 |
| 000-11553-001 |  H5000 Audible Alarm Module provides a configurable audible alarm connected anywhere on the network. | 205.00 | 243.95 |
| 000-13323-001 |  The H5000 Fastnet Interface provides a B&G supported solution for customers wishing to progressively upgrade H3000 systems and/or replace displays on an H3000 system with the latest H5000 Graphic displays. | 195.00 | 232.05 |

Accessories

| Part Number | Description | RRP excl. (EUR) | RRP incl. (19.0%) |
|---------------|--------------------------------------------------------------------------------------------------------------------------------------------------------------------------------------------------------------------------------------------------------------------------------------------------------------------------------------------------------------|-----------------|-------------------|
| 000-14382-001 |  WS310 Wired Wind Sensor with 20m (65.5ft) mast cable and interface for connection to the NMEA 2000® network. | 549.00 | 653.31 |
| 000-15611-001 |  B&G Nemesis™ 9" Sailing Display. The Ultimate sailing display providing visibility & versatility, complete customization and total integration. | 1999.00 | 2378.81 |
| 000-11552-001 |  H5000 Barometric Pressure Sensor provides High-Resolution measurement of Barometric Pressure to the system. | 303.00 | 360.57 |
| 000-15134-001 |  Triton™ Edge Sailing Processor with NMEA 2000®, Ethernet and built-in Wi-Fi. | 1510.00 | 1796.90 |
| 000-15974-001 |  Sail Performance sensor pack. Includes WS320 wind pack, IDST-850 transducer, ZG100 GPS antenna, and Micro-C backbone kit and cables. | 1427.00 | 1698.13 |
| 000-14383-001 |  WS320 Wireless Wind Sensor including Wireless Interface for connection to NMEA 2000® networks. For masts up to 25m in height. | 659.00 | 784.21 |
| 000-11725-001 |  Allows expansion of an H5000 system to include additional analogue and pulse signals from compatible 3rd party sensors. H5000 provides options for these inputs to be assigned to a known function type or to be set up as a custom input with name defined by the user. | 855.00 | 1017.45 |
| 000-11726-001 |  H5000 Serial Expansion allows expansion of an H5000 system. Provides additional serial interfacing options. Typically used for interfacing B&G HGSC heading sensor, GPS sensors, 3rd party heading sensors and other NMEA 0183 devices. | 855.00 | 1017.45 |





| Part Number | Description | RRP excl. (EUR) | RRP incl. (19.0%) |
|---------------|-------------------------------------------------------------------------------------------------------------------------------------|-----------------|-------------------|
| 000-11760-001 |  Missing Image H5000 CPU UNLOCK CODE HYDRA TO PERF | 2380.00 | 2832.20 |
| 000-11759-001 |  Missing Image H5000 CPU UNLOCK CODE HERC TO PERF | 1510.00 | 1796.90 |
| 000-11758-001 |  Missing Image H5000 CPU UNLOCK CODE HYDRA TO HERC | 870.00 | 1035.30 |

Spare Parts



| Part Number | Description | RRP excl. (EUR) | RRP incl. (19.0%) |
|---------------|-------------------------------------------------------------------------------------------------------------------------------------------------------------------------------------------------------------------------------------------------|-----------------|-------------------|
| 000-12892-001 | SUN COVER,H5000 DISPLAYS | 20.00 | 23.80 |
| 000-11542-001 |  H5000 Graphic Display - A 5-inch colour display with a straightforward user interface packed with unique sailing features including SailSteer and Start Line. | 1070.00 | 1273.30 |
| 000-15545-001 |  Missing Image Gasket for H5000 Graphic/Race Displays 5-pack | 15.00 | 17.85 |
| 000-12614-001 | H5000 Displays - Edge Cover Set | 8.00 | 9.52 |
| 000-12899-001 | USB PORT COVER,H5000 GRAPHIC DISPLAY | 10.00 | 11.90 |
| 000-12897-001 | GROMMET PACK,H5000 MODULES | 16.48 | 19.61 |
| 000-12896-001 | GROMMET PACK,H5000 CPU | 16.48 | 19.61 |
| 000-12898-001 | CONN PACK,H5000 EXPANSION MODULES | 23.69 | 28.19 |
| 000-12894-001 | CONN PACK,H5000 CPU | 65.00 | 77.35 |

WTP3







Main Products

| Part Number | Description | RRP excl. (EUR) | RRP incl. (19.0%) |
|---------------|-------------------------------------------------------------------------------------------------------------------------------------------------------------------------------------------------------------------------------------|-----------------|-------------------|
| 000-11550-002 |  B&G Hercules® WTP Sailing Processor Base Pack. H5000 Graphic, Hercules® WTP Sailing Processor, Micro-C Backbone kit | 7776.00 | 9253.44 |
| 000-15136-001 |  Hercules® WTP Sailing Processor. | 7480.00 | 8901.20 |
| 000-10316-001 |  WTP3 Analogue Module - Provides analogue data acquisition, and includes a range of input and output options to support a wide variety of sensors. | 1070.00 | 1273.30 |
| 000-10308-001 |  WTP3 Serial Module - Provides serial data acquisition, and includes a range of input and output options to support a wide variety of sensors. | 1070.00 | 1273.30 |

Accessories

| Part Number | Description | RRP excl. (EUR) | RRP incl. (19.0%) |
|---------------|-------------------------------------------------------------------------------------------------------------------|-----------------|-------------------|
| 000-15137-001 |  HERCULES EXPANSION MODULE | 1595.00 | 1898.05 |
| 000-10396-001 |  Kabel, MICRO-C, Metal, 0.4 m | 29.46 | 35.06 |
| BGH182002 |  H-Pilot ACP2 (Mk.2) Unterteil | 2650.00 | 3153.50 |

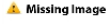

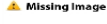

Spare Parts

| Part Number | Description | RRP excl. (EUR) | RRP incl. (19.0%) |
|---------------|---------------------------------------------------------------------------------------------------------------------------------------------------------------------------------------------------------------------------------------------------|-----------------|-------------------|
| 000-10760-001 |  NMEA 2000 Micro-C Auto pilot network starter kit: Includes Network power cable, 4.5 m (15 ft) N2K cable, 3 x T-connectors, and 2 x network terminators. | 90.00 | 107.10 |
| 000-15136-001 |  Hercules® WTP Sailing Processor. | 7480.00 | 8901.20 |
| 000-11542-001 |  H5000 Graphic Display - A 5-inch colour display with a straightforward user interface packed with unique sailing features including SailSteer and Start Line. | 1070.00 | 1273.30 |
| 288-00-001 |  Anschlußdose - 7 Anschlüsse | 42.00 | 49.98 |
| 000-10403-001 |  T-Joiner, Micro-C, Metal | 36.26 | 43.14 |
| BGH214015 |  H3000 GFD/GPD Schutzkappen | 25.00 | 29.75 |
| 000-10311-001 |  WTP3 FastNet Cable - 2m (6.6ft) | 115.36 | 137.28 |





| Part Number | Description | RRP excl. (EUR) | RRP incl. (19.0%) |
|---------------|----------------------------------------------------------------------------------------------------------------------------------------------------------------|--------------------|----------------------|
| 000-10404-001 |  Missing Image MICRO-C,Kupplung mit weiblichem Eingang und Männlichem Ausgang | 27.19 | 32.36 |

HVision

Main Products



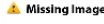
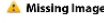
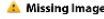

| Part Number | Description | RRP excl. (EUR) | RRP incl. (19.0%) |
|---------------|--------------------------------------------------------------------------------------------------------------------------------|-----------------|-------------------|
| 000-11087-001 |  10/10HV display for H5000 or Triton systems. | 599.46 | 713.36 |
| 000-11088-001 |  20/20HV display for H5000 or Triton systems. | 856.96 | 1019.78 |
| 000-11089-001 |  30/30HV display for H5000 or Triton systems. | 1699.50 | 2022.41 |
| 000-11090-001 |  40/40HV display for H5000 or Triton systems. | 3079.70 | 3664.84 |

Accessories

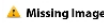
| Part Number | Description | RRP excl. (EUR) | RRP incl. (19.0%) |
|---------------|----------------------------------------------------------------------------------------------------------------------------------------------------------------|-----------------|-------------------|
| 000-15134-001 |  Triton™ Edge Sailing Processor with NMEA 2000®, Ethernet and built-in Wi-Fi. | 1510.00 | 1796.90 |
| BGH220013 |  20/20 HV Mast Halter (3-fach) | 220.00 | 261.80 |
| BGH220014 |  20/20 HV Mast Halter (4-fach) | 310.00 | 368.90 |
| BGH220015 |  20/20 HV Mast Halter (5-fach) | 378.00 | 449.82 |
| BGH291017 |  20/20HV Rahmen (weiß) | 61.00 | 72.59 |
| BGH291018 |  20/20HV Rahmen (Rot) | 61.00 | 72.59 |
| BGH291019 |  20/20HV Rahmen (Grün) | 61.00 | 72.59 |

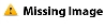

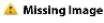
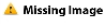
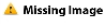
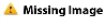
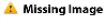







Spare Parts

| Part Number | Description | RRP excl. (EUR) | RRP incl. (19.0%) |
|---------------|------------------------------------------------------------------------------------------------------------------------|-----------------|-------------------|
| 000-15546-001 |  Gasket for 20/20 HV Display 5-pack | 17.00 | 20.23 |



| Part Number | Description | RRP excl. (EUR) | RRP incl. (19.0%) |
|---------------|----------------------------------------------------------------------------------------------------------------------|--------------------|----------------------|
| 000-15547-001 |  Gasket for 30/30 HV Display 5-pack | 48.00 | 57.12 |
| 000-15548-001 |  Gasket for 40/40 HV Display 5-pack | 86.00 | 102.34 |
| BGH281011 |  40/40HV Rahmen (schwarz) | 66.00 | 78.54 |
| BGH284014 |  40/40HV Sun Cover | 37.00 | 44.03 |
| BGH241011 |  30/30HV Rahmen schwarz | 60.00 | 71.40 |
| BGH244014 |  30/30HV Sun Cover | 36.00 | 42.84 |
| BGH291011 |  20/20HV Rahmen (schwarz) | 45.00 | 53.55 |
| BGH324014 |  10/10HV Sun Cover | 20.00 | 23.80 |
| BGH214015 |  H3000 GFD/GPD Schutzkappen | 25.00 | 29.75 |

Analog

Main Products



| Part Number | Description | RRP excl. (EUR) | RRP incl. (19.0%) |
|---------------|----------------------------------------------------------------------------------------------------------------------|-----------------|-------------------|
| 000-11714-001 |  H5000 ANALOGUE AWA 360 | 690.00 | 821.10 |
| 000-11715-001 |  H5000 ANALOGUE TWA 360 | 690.00 | 821.10 |
| 000-11716-001 |  H5000 ANALOGUE AWS 0-50KT | 690.00 | 821.10 |
| 000-11717-001 |  H5000 ANALOGUE TWS 0-50KT | 690.00 | 821.10 |
| 000-11718-001 |  H5000 ANALOGUE MAG AWA | 690.00 | 821.10 |
| 000-11719-001 |  H5000 ANALOGUE BOAT SPEED 12.5KT | 690.00 | 821.10 |
| 000-11721-001 |  H5000 ANALOGUE BOAT SPEED 25KT | 690.00 | 821.10 |
| 000-11720-001 |  H5000 ANALOGUE DEPTH 200M | 690.00 | 821.10 |
| 000-11724-001 |  H5000 ANALOGUE FT/FATH DEPTH | 690.00 | 821.10 |
| 000-11722-001 |  H5000 ANALOGUE HEADING | 690.00 | 821.10 |
| 000-11723-001 |  H5000 ANALOGUE RUDDER ANGLE | 690.00 | 821.10 |

Accessories

| Part Number | Description | RRP excl. (EUR) | RRP incl. (19.0%) |
|-------------|--------------------------------------------------------------------------------------------------------------------------------------------------------------------------------------------|-----------------|-------------------|
| 24005729 |  SimNet to Micro-C (male) cable that connects a SimNet product to a NMEA 2000® backbone. 0.5 m (1.6 ft) | 38.00 | 45.22 |
| BGH301035 |  B&G SimNet Kabel 0.35m, gewinkelt | 36.00 | 42.84 |

| Part Number | Description | RRP excl. (EUR) | RRP incl. (19.0%) |
|-------------|-------------------------------------------------------------------------------------------------------------|-----------------|-------------------|
| BGH234017 |  H3000 analog Schutzkappen | 18.00 | 21.42 |

Spare Parts







| Part Number | Description | RRP excl. (EUR) | RRP incl. (19.0%) |
|-------------|---------------------------------------------------------------------------------------------------------------------|-----------------|-------------------|
| BGH301035 |  B&G SimNet Kabel 0.35m, gewinkelt | 36.00 | 42.84 |
| BGH231021 |  H3000 Analog: Echolot ft/fathoms | 28.00 | 33.32 |
| BGH234017 |  H3000 analog Schutzkappen | 18.00 | 21.42 |

Sensor packs

Main Products



| Part Number | Description | RRP excl. (EUR) | RRP incl. (19.0%) |
|---------------|------------------------------------------------------------------------------------------------------------------------------------------------------------------------------------------------------------------------|-----------------|-------------------|
| 000-15974-001 |  Sail Performance sensor pack. Includes WS320 wind pack, IDST-850 transducer, ZG100 GPS antenna, and Micro-C backbone kit and cables. | 1427.00 | 1698.13 |

Spare Parts





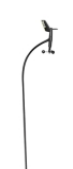

| Part Number | Description | RRP excl. (EUR) | RRP incl. (19.0%) |
|---------------|-------------------------------------------------------------------------------------------------------------------------------------------------------------------------------------------------------------------------------------------|-----------------|-------------------|
| 000-11048-002 |  The ZG100 GPS Antenna with Integrated Compass sensor providing Heading, Heel and Trim. | 279.00 | 332.01 |
| 000-15735-001 |  DST-810 Depth/Speed/Temp Sensor. Plastic thru-hull housing. | 389.00 | 462.91 |
| 000-10760-001 |  NMEA 2000 Micro-C Auto pilot network starter kit: Includes Network power cable, 4.5 m (15 ft) N2K cable, 3 x T-connectors, and 2 x network terminators. | 90.00 | 107.10 |
| 000-14383-001 |  WS320 Wireless Wind Sensor including Wireless Interface for connection to NMEA 2000® networks. For masts up to 25m in height. | 659.00 | 784.21 |
| 000-0127-53 |  N2KEXT-6RD - 1.82 m (6-ft) NMEA 2000® Netzwirkabel | 50.00 | 59.50 |
| 000-0119-86 |  N2KEXT-15RD - 4.55 m (15-ft) NMEA 2000® Netzwirkabel | 56.00 | 66.64 |

700 Series Wind







Main Products









| Part Number | Description | RRP excl. (EUR) | RRP incl. (19.0%) |
|---------------|-------------------------------------------------------------------------------------------------------------------------------------------------------------------------|-----------------|-------------------|
| 000-14384-001 |  WS710 (0.8m) Vertical Wind Sensor Pack: Comes with 35m mast cable and junction box. | 2290.00 | 2725.10 |
| 000-14385-001 |  WS720 (1050mm) Vertical Wind Sensor Pack: Comes with 35m mast cable and junction box | 2760.00 | 3284.40 |
| 000-14386-001 |  WS730 (1450mm) Vertical Wind Sensor Pack. Comes with 35m mast cable and junction box. | 3230.00 | 3843.70 |
| 000-14392-001 |  WS710 Vertical Wind Sensor Only (0.8m) | 2140.00 | 2546.60 |
| 000-14393-001 |  WS720 Vertical Wind Sensor Only (1050mm) | 2605.00 | 3099.95 |
| 000-14983-001 |  WS720S Ocean Spec Vertical Wind Sensor Only (1050mm) | 2865.00 | 3409.35 |
| 000-14394-001 |  WS730 Vertical Wind Sensor Only (1450mm) | 3080.00 | 3665.20 |
| 000-14984-001 |  WS730S Ocean Spec Vertical Wind Sensor Only (1450mm) | 3380.00 | 4022.20 |
| 000-14395-001 |  WS740S Ocean Spec Vertical Wind Sensor Only (1800mm) | 3940.00 | 4688.60 |

Accessories

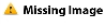
| Part Number | Description | RRP excl. (EUR) | RRP incl. (19.0%) |
|---------------|---------------------------------------------------------------------------------------------------------------------------------------------------------------------------------------|-----------------|-------------------|
| 000-14396-001 |  20m (65') mast cable with pre-molded connectors for the WS310 and WS700 series wired wind sensors. | 85.00 | 101.15 |
| 000-14397-001 |  35m (115') mast cable with pre-molded connectors for the WS310 and WS700 series wired wind sensors. | 128.00 | 152.32 |
| 000-14398-001 |  50m (164') mast cable with pre-molded connectors for the WS310 and WS700 series wired wind sensors. | 525.30 | 625.11 |
| 000-14399-001 |  80m (262') mast cable with pre-molded connectors for the WS310 and WS700 series wired wind sensors. | 813.70 | 968.30 |
| 000-15090-001 |  WS700 Wired Interface. Converts NMEA 0183 wind data from the Masthead Unit to NMEA 2000®. | 125.00 | 148.75 |
| BGH030008 |  VMHU Top Mount Bracket | 198.00 | 235.62 |
| BGH030009 |  VMHU Face Mount Bracket | 185.00 | 220.15 |

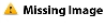









Spare Parts

| Part Number | Description | RRP excl. (EUR) | RRP incl. (19.0%) |
|---------------|----------------------------------------------------------------------------------------------------------------------------------------------------------------------------------------|-----------------|-------------------|
| 000-15144-001 |  Wind vane assembly spare for WS300/700 series wind sensors. Inc. mounting nut. | 48.00 | 57.12 |
| 000-15143-001 |  WS300/700 Support Moulding inc. O-Ring | 17.00 | 20.23 |
| 000-14392-001 |  WS710 Vertical Wind Sensor Only (0.8m) | 2140.00 | 2546.60 |
| 000-14393-001 |  WS720 Vertical Wind Sensor Only (1050mm) | 2605.00 | 3099.95 |
| 000-15142-001 |  Replacement wind angle bearing for the WS300/700 series wind sensors. | 83.00 | 98.77 |
| 000-14396-001 |  20m (65') mast cable with pre-molded connectors for the WS310 and WS700 series wired wind sensors. | 85.00 | 101.15 |





| Part Number | Description | RRP excl. (EUR) | RRP incl. (19.0%) |
|---------------|-------------------------------------------------------------------------------------------------------------------------------------------------------------------------------------------|-----------------|-------------------|
| 000-14397-001 |  35m (115') mast cable with pre-molded connectors for the WS310 and WS700 series wired wind sensors. | 128.00 | 152.32 |
| 000-14394-001 |  WS730 Vertical Wind Sensor Only (1450mm) | 3080.00 | 3665.20 |
| 000-15140-001 |  Wind Speed Cup spare for all B&G MHUs (508, 608, 213, VMHU, WS300, WS700) | 31.00 | 36.89 |
| 000-14398-001 |  50m (164') mast cable with pre-molded connectors for the WS310 and WS700 series wired wind sensors. | 525.30 | 625.11 |
| 000-14399-001 |  80m (262') mast cable with pre-molded connectors for the WS310 and WS700 series wired wind sensors. | 813.70 | 968.30 |
| 000-15139-001 |  Replacement PCB for WS700/310 series wind sensors. | 298.00 | 354.62 |
| 213-10-038 |  Replacement wind speed bearing for all B&G MHUs (508, 608, 213, VMHU, WS300, WS700) | 92.00 | 109.48 |
| MHU-NUTS |  Replacement mounting nuts for wind vane and cups for all B&G MHUs (508, 608, 213, VMHU, WS300, WS700) | 20.00 | 23.80 |
| BGH030008 |  VMHU Top Mount Bracket | 198.00 | 235.62 |
| BGH030009 |  VMHU Face Mount Bracket | 185.00 | 220.15 |



Wind

Main Products















| Part Number | Description | RRP excl. (EUR) | RRP incl. (19.0%) |
|---------------|-----------------------------------------------------------------------------------------------------------------------------------------------------------------------------------------------------------------|-----------------|-------------------|
| 000-14382-001 |  WS310 Wired Wind Sensor with 20m (65.5ft) mast cable and interface for connection to the NMEA 2000® network. | 549.00 | 653.31 |
| 000-14843-001 |  WS310 Wired Wind Sensor with 35m (115ft) mast cable and interface for connection to the NMEA 2000® network. | 587.00 | 698.53 |
| 000-14383-001 |  WS320 Wireless Wind Sensor including Wireless Interface for connection to NMEA 2000® networks. For masts up to 25m in height. | 659.00 | 784.21 |
| 000-14391-001 |  WS310 Wired Wind Sensor only. | 454.00 | 540.26 |
| 000-14390-001 |  WS320 Wireless Wind Sensor only. | 539.00 | 641.41 |
| 000-14396-001 |  20m (65') mast cable with pre-molded connectors for the WS310 and WS700 series wired wind sensors. | 85.00 | 101.15 |
| 000-14397-001 |  35m (115') mast cable with pre-molded connectors for the WS310 and WS700 series wired wind sensors. | 128.00 | 152.32 |
| 000-14398-001 |  50m (164') mast cable with pre-molded connectors for the WS310 and WS700 series wired wind sensors. | 525.30 | 625.11 |
| 000-14399-001 |  80m (262') mast cable with pre-molded connectors for the WS310 and WS700 series wired wind sensors. | 813.70 | 968.30 |
| 000-15090-001 |  WS700 Wired Interface. Converts NMEA 0183 wind data from the Masthead Unit to NMEA 2000®. | 125.00 | 148.75 |
| 000-14389-001 |  WS310 Wired Interface. Converts NMEA 0183 wind data from the Masthead Unit to NMEA 2000®. | 99.00 | 117.81 |

Accessories

| Part Number | Description | RRP excl. (EUR) | RRP incl. (19.0%) |
|---------------|-----------------------------------------------------------------------------------------------------------------------------------------------------------------------------------------|-----------------|-------------------|
| 000-14396-001 |  20m (65') mast cable with pre-molded connectors for the WS310 and WS700 series wired wind sensors. | 85.00 | 101.15 |
| 000-14397-001 |  35m (115') mast cable with pre-molded connectors for the WS310 and WS700 series wired wind sensors. | 128.00 | 152.32 |
| 000-14398-001 |  50m (164') mast cable with pre-molded connectors for the WS310 and WS700 series wired wind sensors. | 525.30 | 625.11 |
| 000-14399-001 |  80m (262') mast cable with pre-molded connectors for the WS310 and WS700 series wired wind sensors. | 813.70 | 968.30 |

| Part Number | Description | RRP excl. (EUR) | RRP incl. (19.0%) |
|---------------|------------------------------------------------------------------------------------------------------------------------------------------------------------------------------------------------------------------------------------------------|-----------------|-------------------|
| 000-15090-001 |  WS700 Wired Interface. Converts NMEA 0183 wind data from the Masthead Unit to NMEA 2000®. | 125.00 | 148.75 |
| 000-14389-001 |  WS310 Wired Interface. Converts NMEA 0183 wind data from the Masthead Unit to NMEA 2000®. | 99.00 | 117.81 |
| 000-14388-001 |  The WS320 Wireless Interface: Spare Wireless Interface for the WS320 Wind Sensor system. Receives wireless signals from the WS320 and converts to NMEA 2000. | 182.00 | 216.58 |





Spare Parts

| Part Number | Description | RRP excl. (EUR) | RRP incl. (19.0%) |
|---------------|--------------------------------------------------------------------------------------------------------------------------------------------------------------------------------------------------------------------------------------------------|-----------------|-------------------|
| 000-15144-001 |  Wind vane assembly spare for WS300/700 series wind sensors. Inc. mounting nut. | 48.00 | 57.12 |
| 000-15615-001 | Replacement PCB for the WS320 wind sensor. | 298.00 | 354.62 |
| 000-15143-001 |  WS300/700 Support Moulding inc. O-Ring | 17.00 | 20.23 |
| 000-14391-001 |  WS310 Wired Wind Sensor only. | 454.00 | 540.26 |
| 000-14396-001 |  20m (65') mast cable with pre-molded connectors for the WS310 and WS700 series wired wind sensors. | 85.00 | 101.15 |
| 000-15142-001 |  Replacement wind angle bearing for the WS300/700 series wind sensors. | 83.00 | 98.77 |
| 000-15140-001 |  Wind Speed Cup spare for all B&G MHUs (508, 608, 213, VMHU, WS300, WS700) | 31.00 | 36.89 |
| 000-15141-001 |  Replacement battery for WS320 wireless wind sensor. | 22.00 | 26.18 |
| 000-15139-001 |  Replacement PCB for WS700/310 series wind sensors. | 298.00 | 354.62 |
| 213-10-038 |  Replacement wind speed bearing for all B&G MHUs (508, 608, 213, VMHU, WS300, WS700) | 92.00 | 109.48 |
| 000-14389-001 |  WS310 Wired Interface. Converts NMEA 0183 wind data from the Masthead Unit to NMEA 2000®. | 99.00 | 117.81 |
| MHU-NUTS |  Replacement mounting nuts for wind vane and cups for all B&G MHUs (508, 608, 213, VMHU, WS300, WS700) | 20.00 | 23.80 |
| 000-14388-001 |  The WS320 Wireless Interface: Spare Wireless Interface for the WS320 Wind Sensor system. Receives wireless signals from the WS320 and converts to NMEA 2000. | 182.00 | 216.58 |
| 000-13715-001 |  608 Wind Sensor spare PCB assembly. Compatible with 608 and 508 Wind Sensors | 190.00 | 226.10 |
| 000-10573-001 |  IS20 Windfahnen Masthalterung | 65.92 | 78.44 |
| 213-10-004 |  Windrichtung Lager (für 213 oder 496 Windmeßgeber) | 83.00 | 98.77 |



| Part Number | Description | RRP excl. (EUR) | RRP incl. (19.0%) | |
|-------------|-------------------------------------------------------------------------------------------------|--------------------------------------------|----------------------|-------|
| 213-10-056 |  Missing Image | Wind Fahne (für 213 oder 496 Windmeßgeber) | 42.00 | 49.98 |

Speed/Depth

Main Products

| Part Number | Description | RRP excl. (EUR) | RRP incl. (19.0%) |
|---------------|-----------------------------------------------------------------------------------------------------------------------------------------------------------------------------------|-----------------|-------------------|
| 000-15735-001 |  DST-810 Depth/Speed/Temp Sensor. Plastic thru-hull housing. | 389.00 | 462.91 |
| 000-15736-001 |  DST-810 Depth/Speed/Temp Sensor. Bronze thru-hull housing | 499.00 | 593.81 |
| 000-11738-001 |  DT800 Depth/Temp Sensor. Plastic thru-hull housing. | 349.00 | 415.31 |
| 000-11852-001 |  Airmar IDST800L 235F B-122-RETR 6M | 658.90 | 784.09 |
| 22098586 |  ST850 passive S/T sensor TH plastic with 1 m (7 ft) Pigtail (Connects speed to D800 (22098560)) | 117.00 | 139.23 |

Spare Parts



| Part Number | Description | RRP excl. (EUR) | RRP incl. (19.0%) |
|---------------|--------------------------------------------------------------------------------------------------------------------------------------|-----------------|-------------------|
| 000-10567-001 |  P617V DST HSG VLV KIT | 54.00 | 64.26 |
| 000-10568-001 |  Missing image Accessory plug assembly for DST800 | 24.00 | 28.56 |
| 000-10388-001 | Ersatzteil Kit Paddelrad für DST800 | 35.00 | 41.65 |

Heading

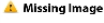

Main Products

| Part Number | Description | RRP excl. (EUR) | RRP incl. (19.0%) |
|---------------|------------------------------------------------------------------------------------------------------------------------------------------------------------------------------------|-----------------|-------------------|
| 000-12607-001 |  Precision-9 Compass - Outputs Heading, Rate Of Turn, Roll and Pitch over the NMEA 2000® network. | 669.00 | 796.11 |

Accessories



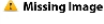
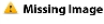

| Part Number | Description | RRP excl. (EUR) | RRP incl. (19.0%) |
|---------------|---------------------------------------------------------------------------------------------------------------------------------------------------------------------|-----------------|-------------------|
| 000-0127-45 |  SimNet auf N2K Adapter-Kit - verbindet SimNet-Komponenten mit NMEA 2000® Netzwerk | 118.51 | 141.03 |
| 000-10640-001 |  HS70 Power / NMEA0183 Kabel, 15m | 347.00 | 412.93 |
| 000-10641-001 |  HS70 programming Kabel | 414.00 | 492.66 |
| 000-10937-001 |  HS70 SERIAL-TO-N2K ADAPTER | 143.00 | 170.17 |

Spare Parts

| Part Number | Description | RRP excl. (EUR) | RRP incl. (19.0%) |
|---------------|--------------------------------------------------------------------------------------------------------------------------------|-----------------|-------------------|
| BGH063001 |  Halcyon Gyro-Stabilised Kompassgeber Kabel | 218.00 | 259.42 |
| 000-10641-001 |  HS70 programming Kabel | 414.00 | 492.66 |
| 000-10937-001 |  HS70 SERIAL-TO-N2K ADAPTER | 143.00 | 170.17 |

Environment

Main Products

| Part Number | Description | RRP excl. (EUR) | RRP incl. (19.0%) |
|---------------|----------------------------------------------------------------------------------------------------------------------------------------------------------------------------------------------------------------------------------------------------------------------------------------------|-----------------|-------------------|
| 000-16154-001 |  Airmar® 110WX WeatherStation® Sensor Only | 889.00 | 1057.91 |
| 000-11552-001 |  H5000 Barometric Pressure Sensor provides High-Resolution measurement of Barometric Pressure to the system. | 303.00 | 360.57 |
| 000-11520-001 |  Temperature Sensor - Can be mounted anywhere you want to monitor the temperature. Can be configured to output a variety of different temperature types. | 119.00 | 141.61 |
| 000-11521-001 |  Through-Hull Temperature Sensor - Mount through the hull of the vessel or wall of a tank you want to monitor the temperature inside. Can be configured to output a variety of different temperature types. | 108.90 | 129.59 |

Accessories



| Part Number | Description | RRP excl. (EUR) | RRP incl. (19.0%) |
|---------------|--------------------------------------------------------------------------------------------------------------------------------------------------------|-----------------|-------------------|
| 000-11740-001 |  Airmar 110WX/ 120WX Cable 6 m (19.6 ft) (NMEA 2000 to Device cable) | 60.00 | 71.40 |

Spare Parts

| Part Number | Description | RRP excl. (EUR) | RRP incl. (19.0%) |
|---------------|---------------------------------------------------------------------------------------------------------------------------------------------------------|-----------------|-------------------|
| 000-11740-001 |  Airmar 110WX/ 120WX Cable 6 m (19.6 ft) (NMEA 2000 to Device cable) | 60.00 | 71.40 |

GPS

Main Products

| Part Number | Description | RRP excl. (EUR) | RRP incl. (19.0%) |
|---------------|--------------------------------------------------------------------------------------------------------------------------------------------------------------------------------------------------------------------------------------------------------------------------------------------------------------------|-----------------|-------------------|
| 000-11048-002 |  The ZG100 GPS Antenna with Integrated Compass sensor providing Heading, Heel and Trim. | 279.00 | 332.01 |
| 000-11571-002 |  The ZG100 Antenna provides high accuracy position at a 10Hz update rate. Built in rate compass is perfect for for providing heading data for Radar Chart Overlay and for orienting charts in Head Up Mode. - Boatbuilder 6-pack. | 279.00 | 332.01 |

Accessories



| Part Number | Description | RRP excl. (EUR) | RRP incl. (19.0%) |
|---------------|-------------------------------------------------------------------------------------------------------------------------|-----------------|-------------------|
| 000-11148-001 |  Pole Mount for GS25 / ZG100 / POINT-1 | 30.00 | 35.70 |

Spare Parts





| Part Number | Description | RRP excl. (EUR) | RRP incl. (19.0%) |
|---------------|-------------------------------------------------------------------------------------------------------------------------|-----------------|-------------------|
| 000-11148-001 |  Pole Mount for GS25 / ZG100 / POINT-1 | 30.00 | 35.70 |

Andere

Main Products







| Part Number | Description | RRP excl. (EUR) | RRP incl. (19.0%) |
|---------------|---------------------------------------------------------------------------------------------------------------------------------------------------------------------------------------------------------------------|-----------------|-------------------|
| 000-15940-001 |  NMEA 2000® Remote MOB Button. An emergency Man-Over-Board (MOB) button, which will trigger alerts across the NMEA2000® network. | 167.00 | 198.73 |
| 000-11518-001 |  Fluid Level Sensor - Connects to a standard suitable tank level sensor and transmits the tank level on the the NMEA 2000 network. | 109.00 | 129.71 |

Accessories







| Part Number | Description | RRP excl. (EUR) | RRP incl. (19.0%) |
|---------------|----------------------------------------------------------------------------------------------------------------------------------------------------------------------------------|-----------------|-------------------|
| 000-12612-001 |  Low loss NMEA2000 4-way joiner. Connect four NMEA2000 Micro-C devices to the NMEA2000 Network. | 54.00 | 64.26 |
| 000-0119-88 |  N2KEXT-2RD - 0.61 m (2-ft) NMEA 2000® Netzwerkkabel | 32.00 | 38.08 |
| 000-0127-53 |  N2KEXT-6RD - 1.82 m (6-ft) NMEA 2000® Netzwerkkabel | 50.00 | 59.50 |
| 000-0119-86 |  N2KEXT-15RD - 4.55 m (15-ft) NMEA 2000® Netzwerkkabel | 56.00 | 66.64 |

Wind

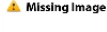
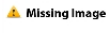







Main Products

| Part Number | Description | RRP excl. (EUR) | RRP incl. (19.0%) |
|-------------|---------------------------------------------------------------------------------------------------------------------------------------------------------------------------------------------------------------------------------------------------|-----------------|-------------------|
| BGH031001 |  Vertical Masthead Unit 810mm Only. Analog Wind Sensor for WPT3, H3000 and H5000. | 2140.00 | 2546.60 |
| BGH031002 |  Vertical Masthead Unit 1050mm Only. Analog Wind Sensor for WPT3, H3000 and H5000. | 2605.00 | 3099.95 |
| BGH031002/S |  Vertical Masthead Unit Ocean Spec 1050mm Only. Analog Wind Sensor for WPT3, H3000 and H5000. | 2900.00 | 3451.00 |
| BGH031003 |  Vertical Masthead Unit 1450mm Only. Analog Wind Sensor for WPT3, H3000 and H5000. | 3080.00 | 3665.20 |
| BGH031003/S |  Vertical Masthead Unit Ocean Spec 1450mm Only. Analog Wind Sensor for WPT3, H3000 and H5000. | 3380.00 | 4022.20 |
| BGH031010 |  Vertical Masthead Unit 1800mm Only. Analog Wind Sensor for WPT3, H3000 and H5000. | 3950.00 | 4700.50 |
| 213-00-002 |  The 213 Masthead unit is an ocean-proven high performance wind sensor, providing raw wind speed and angle data to the instrument system. For H5000 and H3000. | 1040.00 | 1237.60 |

Accessories





| Part Number | Description | RRP excl. (EUR) | RRP incl. (19.0%) |
|-------------|---------------------------------------------------------------------------------------------------------------------------------------------------------------------|-----------------|-------------------|
| BGH030006 |  36m extra leicht Mast Kabel (für 213 Vertikaler Windmeßgeber) | 430.00 | 511.70 |
| BGH030007 |  50m extra leicht Mast Kabel (für 213 Vertikaler Windmeßgeber) | 596.00 | 709.24 |
| BGH030008 |  VMHU Top Mount Bracket | 198.00 | 235.62 |
| BGH030009 |  VMHU Face Mount Bracket | 185.00 | 220.15 |
| 178-0B-001 |  24m Mast Kabel und Halter (für 213 Windmeßgeber, Standart Version) | 336.00 | 399.84 |
| 178-0D-001 |  36m Mast Kabel und Halter (für 213 Windmeßgeber, Standart Version) | 440.00 | 523.60 |
| 178-0X-001 |  36m extra leicht Mast Kabel und Halter (für 213 Windmeßgeber, Standart Version) | 570.00 | 678.30 |

Spare Parts











| Part Number | Description | RRP excl. (EUR) | RRP incl. (19.0%) |
|-------------|-----------------------------------------------------------------------------------------------------------------------------------------------------------------------------------------|-----------------|-------------------|
| 213-10-038 |  Replacement wind speed bearing for all B&G MHUs (508, 608, 213, VMHU, WS300, WS700) | 92.00 | 109.48 |
| MHU-NUTS |  Replacement mounting nuts for wind vane and cups for all B&G MHUs (508, 608, 213, VMHU, WS300, WS700) | 20.00 | 23.80 |
| 178-30-023 |  Missing Image 213 Kabel Mutter (Kabel an Halter) | 63.00 | 74.97 |
| 213-10-003 |  Missing Image 213 Windmeßgeber nur Gehäuse (Standart Version) | 480.00 | 571.20 |
| 213-10-004 |  Missing Image Windrichtung Lager (für 213 oder 496 Windmeßgeber) | 83.00 | 98.77 |
| 213-10-056 |  Missing Image Wind Fahne (für 213 oder 496 Windmeßgeber) | 42.00 | 49.98 |
| 213-10-101 |  Missing Image 213 Windmeßgeber Platine | 359.00 | 427.21 |
| MHU-MLDGS |  Missing Image 213/496 Aussengehäuse | 62.00 | 73.78 |

Speed/Depth

Main Products









| Part Number | Description | RRP excl. (EUR) | RRP incl. (19.0%) |
|-------------|--------------------------------------------------------------------------------------------------------------------------------------------------------|-----------------|-------------------|
| SEN-SPD-HM |  Loggeber Paket, Bronze Seebodengehäuse (H3000, H2000) | 370.00 | 440.30 |
| SEN-SPD-HP |  Loggeber Paket, Kunststoff Seebodengehäuse (H3000, H2000) | 190.00 | 226.10 |
| SEN-SPD-HPF |  Loggeber Paket, Kunststoff versenktem Seebodengehäuse (H3000, H2000) | 190.00 | 226.10 |
| SEN-DPT-A2M |  Tiefensensor NMEA0183 - 235 kHz - Bronze geflanscht | 625.00 | 743.75 |
| SEN-DPT-A2P |  Tiefensensor NMEA0183 - 235 kHz - Bronze geflanscht | 485.00 | 577.15 |

Spare Parts









| Part Number | Description | RRP excl. (EUR) | RRP incl. (19.0%) |
|---------------|----------------------------------------------------------------------------------------------------------------------------------------------------------|-----------------|-------------------|
| SEN-HSG-M |  Sensor Seebodengehäuse - Metal | 240.00 | 285.60 |
| SEN-HSG-P |  Sensor Seebodengehäuse - Kunststoff | 96.00 | 114.24 |
| SEN-HSG-PF |  Sensor Seebodengehäuse - Kunststoff versenkt | 96.00 | 114.24 |
| SEN-INSRT-SP2 |  Sensor Seebodengehäuse - Kunststoff versenkt | 76.00 | 90.44 |
| SEN-PLUG-SP2 |  Seebodengehäuse Blindstopfen (Echolot) | 49.00 | 58.31 |
| SEN-SPEED-H |  Loggeber Paket, Kunststoff versenktem Seebodengehäuse (H3000, H2000) | 160.00 | 190.40 |
| SEN-SPRS-SPD |  Paddelrad Loggeber Ersatzteilsatz (nach 1996 Airmar) | 49.00 | 58.31 |
| SEN-DEPTH-A2 |  Echolot-Sensor, aktiv NMEA0183 - 235 KHz - nur Sensor, ohne Kabel | 390.00 | 464.10 |
| SEN-DEPTH-H |  H3000 Tiefensensor mit 15m Kabel | 160.00 | 190.40 |
| SEN-PLUG-DPT |  Seebodengehäuse Blindstopfen (Echolot) | 49.00 | 58.31 |









Triton².

Main Products





| Part Number | Description | RRP excl. (EUR) | RRP incl. (19.0%) |
|---------------|-------------------------------------------------------------------------------------------------------------------------------------------------------------------------------------------------------------------------------------------------------------------------------------------------------|-----------------|-------------------|
| 000-13296-001 |  Triton ² Pilot Controller. This intuitive keypad can be combined with a B&G Triton ² Display to create a fully-featured autopilot controller. | 345.00 | 410.55 |
| 000-12316-001 |  WR10 Wireless Autopilot Remote. Includes NMEA2000 connected Bluetooth base station. | 479.00 | 570.01 |
| 000-13249-001 |  The low-current NAC-2 autopilot computer is ideal for smaller vessels, designed to run small hydraulic drives and mechanical drives for vessels up to 10 metres (33 feet) in length. Also provides solenoid output. | 939.00 | 1117.41 |
| 000-13335-001 |  NAC-2 Autopilot Core Pack - Comes with NAC-2 Autopilot Computer, Precision-9 Compass and RF-25N Rudder Feedback unit. | 1620.83 | 1928.79 |
| 000-13337-001 |  NAC-2 VRF Autopilot Core Pack - Comes with NAC-2 Autopilot Computer and Precision-9 Compass. | 1354.17 | 1611.46 |
| 000-13250-001 |  The high-current NAC-3 autopilot computer is designed for vessels over 10 metres (33 feet) in length, with the ability to run heavy-duty hydraulic drive pumps & linear rams, and also provides solenoid output. | 1649.00 | 1962.31 |
| 000-13336-001 |  NAC-3 Autopilot Core Pack - Comes with NAC-3 Autopilot Computer, Precision-9 Compass and RF-25N Rudder Feedback unit. | 2379.17 | 2831.21 |
| 000-13338-001 |  NAC-3 VRF Autopilot Core Pack - Comes with NAC-3 Autopilot Computer and Precision-9 Compass. | 2108.33 | 2508.92 |

Accessories

| Part Number | Description | RRP excl. (EUR) | RRP incl. (19.0%) |
|---------------|-----------------------------------------------------------------------------------------------------------------------------------------------------------------------------------------------------------------------------------------------------------------------------------------------------------------------------------------------------------------|-----------------|-------------------|
| 000-12607-001 |  Precision-9 Compass - Outputs Heading, Rate Of Turn, Roll and Pitch over the NMEA 2000® network. | 669.00 | 796.11 |
| 000-14439-001 |  NAC-1 / NAC-2 ONLY. The RF40 is a medium-duty rudder feedback unit designed specific for use with NAC-1 and NAC-2 autopilot computers. 3pin 15m (50ft) cable. | 319.00 | 379.61 |
| 000-13296-001 |  Triton ² Pilot Controller. This intuitive keypad can be combined with a B&G Triton ² Display to create a fully-featured autopilot controller. | 345.00 | 410.55 |
| 000-10756-001 |  RF25N, Ruder Rückgeber Einheit: mit Übertragungs Gestänge und 5 m (16.5 ft) NMEA2000 Micro-C Kabel | 319.00 | 379.61 |
| 20193744 |  RF300 Frequency Rudder Feedback - 10m cable and transmission link assembly. | 287.00 | 341.53 |
| 000-12316-001 |  WR10 Wireless Autopilot Remote. Includes NMEA2000 connected Bluetooth base station. | 479.00 | 570.01 |
| 000-13249-001 |  The low-current NAC-2 autopilot computer is ideal for smaller vessels, designed to run small hydraulic drives and mechanical drives for vessels up to 10 metres (33 feet) in length. Also provides solenoid output. | 939.00 | 1117.41 |
| RAM-T1-12V |  Hydraulic Ram T1 12V High power, efficient drive units for maximum power with minimum consumption. Ram drives allow the Power Steer mode on the Pilot to be used in cases of manual steering failure. Fully Integrated hydraulic system, no external hoses, reservoirs etc. | 1700.00 | 2023.00 |



| Part Number | Description | RRP excl. (EUR) | RRP incl. (19.0%) |
|---------------|---------------------------------------------------------------------------------------------------------------------------------------------------------------------------------------------------------------------------------------------------------------------------------------------------------------------------------------------------------------|-----------------|-------------------|
| RAM-T2-12V |  Hydraulic Ram T2 12V High power, efficient drive units for maximum power with minimum consumption. Ram drives allow the Power Steer mode on the Pilot to be used in cases of manual steering failure. Fully Integrated hydraulic system, no external hoses, reservoirs etc. | 2070.00 | 2463.30 |
| 000-13250-001 |  The high-current NAC-3 autopilot computer is designed for vessels over 10 metres (33 feet) in length, with the ability to run heavy-duty hydraulic drive pumps & linear rams, and also provides solenoid output. | 1649.00 | 1962.31 |
| RAM-T2-24V |  Hydraulic Ram T2 24V High power, efficient drive units for maximum power with minimum consumption. Ram drives allow the Power Steer mode on the Pilot to be used in cases of manual steering failure. Fully Integrated hydraulic system, no external hoses, reservoirs etc. | 2070.00 | 2463.30 |
| RAM-T3-24V |  Hydraulic Ram T3 24V Hydraulic Steering Systems combine a hydraulic cylinder with clutch, reversing pump and reservoir in a compact installation. | 2780.00 | 3308.20 |
| 000-10614-001 |  N2K, IS40 CABLE,MICRO-C,RIGHT ANGLE INTERCONNECT 0.4m (1.3 ft) | 24.00 | 28.56 |
| RAM-T4-24V |  Hydraulik Doppelzylinder mit Dauerläuferpumpe - Typ 4, 24 Volt | 8668.00 | 10314.92 |
| 21119896 |  DD15 Direct Drive unit for sailboats 30'-40' with electromagnetic clutch, lever with tiller pin and RF300 Rudder feedback. 12 V power supply (NAC-3 / H5000 required) | 2250.00 | 2677.50 |
| 000-13697-001 |  SD10 Mechanical Drive unit for NAC-2 Autopilot computers. The Drive will suit sailboats 25'-37' with 6' steering cable with electromagnetic clutch with override function, built in Rudder feedback and 12 V power supply | 1429.00 | 1700.51 |
| 000-14268-001 |  Waterproof 4-core cable joiner for NAC-1, 2 and 3 Autopilot installations. Convenient way to connect your computer to the drive unit and ensure a waterproof connection. | 27.00 | 32.13 |

Spare Parts











| Part Number | Description | RRP excl. (EUR) | RRP incl. (19.0%) |
|---------------|------------------------------------------------------------------------------------------------------------------------------------------------------------------------------------------------------------------------------------------|-----------------|-------------------|
| 000-14463-001 | NAC-2 Spare Drive Cable - 2m (6.5 ft) | 38.00 | 45.22 |
| 000-13725-001 |  Suncover for Simrad OP12 and B&G Triton ² Pilot controllers | 14.00 | 16.66 |
| 000-12359-001 |  WR10 BT-1 Base Station Only | 269.00 | 320.11 |
| 000-12358-001 |  WR10 Wireless Remote for Autopilot. | 209.00 | 248.71 |
| 000-13952-001 |  Triton2 Pilot & OP12 Installation Kit | 14.00 | 16.66 |
| 000-14798-001 |  NAC-2 Rudder feedback cable: Used to connect resistive rudder feedback units to either NAC-1 or NAC-2. 3 Pin connector to 3 bare wires. 2 m (6.5 ft) | 38.00 | 45.22 |

H5000

Main Products

| Part Number | Description | RRP excl. (EUR) | RRP incl. (19.0%) |
|---------------|------------------------------------------------------------------------------------------------------------------------------------------------------------------------------------------------------------------------------------------------------------------------------------------------------------------------------------------------------------------------------------------------------------------------------------------------------------------------|-----------------|-------------------|
| 000-11554-001 |  H5000,Pilot Computer: The record-breaking B&G Pilot features dedicated steering modes and sailing algorithms including Gust Response, Recovery and High Wind Response. It's been proven in the toughest conditions and most testing environments and is ideal for short-handed cruisers or racers. Note: An H5000 Hydra, Hercules or Performance CPU is required to steer to wind | 2260.00 | 2689.40 |
| 000-11544-001 |  H5000 Pilot Controller | 596.00 | 709.24 |

Accessories

| Part Number | Description | RRP excl. (EUR) | RRP incl. (19.0%) |
|---------------|-----------------------------------------------------------------------------------------------------------------------------------------------------------------------------------------------------------------------------------------------------------------------------------------------------------------------------------------------------------------|-----------------|-------------------|
| 000-11544-001 |  H5000 Pilot Controller | 596.00 | 709.24 |
| 000-10756-001 |  RF25N, Ruder Rückgeber Einheit: mit Übertragungs Gestänge und 5 m (16.5 ft) NMEA2000 Micro-C Kabel | 319.00 | 379.61 |
| 20193744 |  RF300 Frequency Rudder Feedback - 10m cable and transmission link assembly. | 287.00 | 341.53 |
| 000-13902-001 |  Hydraulic Ram T0 12V - The RAM T0 Hydraulic linear actuator combines a cylinder, pump, motor, clutch, and reservoir in a pre-filled, sealed unit. Designed to be used on vessels fitted with mechanical primary steering that can be back-driven. | 1540.00 | 1832.60 |
| RAM-T1-12V |  Hydraulic Ram T1 12V High power, efficient drive units for maximum power with minimum consumption. Ram drives allow the Power Steer mode on the Pilot to be used in cases of manual steering failure. Fully Integrated hydraulic system, no external hoses, reservoirs etc. | 1700.00 | 2023.00 |
| RAM-T2-12V |  Hydraulic Ram T2 12V High power, efficient drive units for maximum power with minimum consumption. Ram drives allow the Power Steer mode on the Pilot to be used in cases of manual steering failure. Fully Integrated hydraulic system, no external hoses, reservoirs etc. | 2070.00 | 2463.30 |
| 000-11726-001 |  H5000 Serial Expansion allows expansion of an H5000 system. Provides additional serial interfacing options. Typically used for interfacing B&G HGSC heading sensor, GPS sensors, 3rd party heading sensors and other NMEA 0183 devices. | 855.00 | 1017.45 |
| RAM-T2-24V |  Hydraulic Ram T2 24V High power, efficient drive units for maximum power with minimum consumption. Ram drives allow the Power Steer mode on the Pilot to be used in cases of manual steering failure. Fully Integrated hydraulic system, no external hoses, reservoirs etc. | 2070.00 | 2463.30 |
| 000-13788-001 |  Hydraulic Ram T3 12V Hydraulic Steering Systems combine a hydraulic cylinder with clutch, reversing pump and reservoir in a compact installation. | 2780.00 | 3308.20 |
| RAM-T3-24V |  Hydraulic Ram T3 24V Hydraulic Steering Systems combine a hydraulic cylinder with clutch, reversing pump and reservoir in a compact installation. | 2780.00 | 3308.20 |
| RAM-T4-24V |  Hydraulik Doppelzylinder mit Dauerläuferpumpe - Typ 4, 24 Volt | 8668.00 | 10314.92 |



Spare Parts

| Part Number | Description | RRP excl. (EUR) | RRP incl. (19.0%) |
|---------------|---------------------------------------------------------------------------------------------------------------------------|-----------------|-------------------|
| 000-12893-001 | SUN COVER,H5000 PILOT KEYPAD | 18.00 | 21.42 |
| 000-12615-001 |  H5000 Pilot Controller Edge Cover Set | 8.00 | 9.52 |

| Part Number | Description | RRP excl. (EUR) | RRP incl. (19.0%) |
|---------------|----------------------------------------|--------------------|----------------------|
| 000-12895-001 | CONNECTOR PACK (Green),H5000 PILOT CPU | 65.00 | 77.35 |

Sensoren

Main Products













| Part Number | Description | RRP excl. (EUR) | RRP incl. (19.0%) |
|---------------|-------------------------------------------------------------------------------------------------------------------------------------------------------------------------------------------------------------------------------------------------|--------------------|----------------------|
| 000-14439-001 |  NAC-1 / NAC-2 ONLY. The RF40 is a medium-duty rudder feedback unit designed specific for use with NAC-1 and NAC-2 autopilot computers. 3pin 15m (50ft) cable. | 319.00 | 379.61 |
| 000-10756-001 |  RF25N, Ruder Rückgeber Einheit: mit Übertragungs Gestänge und 5 m (16.5 ft) NMEA2000 Micro-C Kabel | 319.00 | 379.61 |
| 20193744 |  RF300 Frequency Rudder Feedback - 10m cable and transmission link assembly. | 287.00 | 341.53 |

Spare Parts



| Part Number | Description | RRP excl. (EUR) | RRP incl. (19.0%) |
|-------------|-----------------------------------------------------------------------------------------------------------------------------------|--------------------|----------------------|
| 20193678 |  Missing Image RF300 Transmission Lever Assembly | 69.00 | 82.11 |



Antriebe

Main Products









| Part Number | Description | RRP excl. (EUR) | RRP incl. (19.0%) |
|---------------|-----------------------------------------------------------------------------------------------------------------------------------------------------------------------------------------------------------------------------------------------------------------------------------------------------------------------------------------------------------------|-----------------|-------------------|
| 000-15444-002 |  PUMP-2: 12V DC: Reversible hydraulic gear pump. 0.8L (49 cu.in) / min. For cylinder displacement of 80 cc - 250 cc (4.9 - 15.2 cu.in). O-Ring Boss (ORB) connections. Includes 3 x ORB-5 to 9/16 UNF fittings. SteadySteer compatible. (NAC-2 / AC12 required). | 719.00 | 855.61 |
| 000-15445-002 |  PUMP-3: 12V DC: Reversible hydraulic gear pump. 1.6L (98 cu.in) / min. For cylinder displacement of 160-550 cc (9.8 - 33.5 cu.in). O-Ring Boss (ORB) connections. Includes 3 x ORB-5 to 9/16 UNF fittings. SteadySteer compatible. (NAC-3 / AC42 required). | 879.00 | 1046.01 |
| 000-15446-002 |  PUMP-4: 12V DC: Reversible hydraulic gear pump. 3.0L (183 cui) / min. For cylinder displacement of 290 - 960 cc (17.7 - 58.5 cu. in.). O-Ring Boss (ORB) connections. Includes 3 x ORB-5 to 9/16 UNF fittings. SteadySteer compatible. (NAC-3 / AC42 required). | 1279.00 | 1522.01 |
| 000-15447-002 |  PUMP-5: 24V DC: Reversible hydraulic gear pump. 3.0L (183 cui) / min. For cylinder displacement of 290 - 960 cc (17.7 - 58.5 cu. in.). O-Ring Boss (ORB) connections. Includes 3 x ORB-5 to 9/16 UNF fittings. SteadySteer compatible. (NAC-3 / AC42 required). | 1279.00 | 1522.01 |
| 000-13902-001 |  Hydraulic Ram T0 12V - The RAM T0 Hydraulic linear actuator combines a cylinder, pump, motor, clutch, and reservoir in a pre-filled, sealed unit. Designed to be used on vessels fitted with mechanical primary steering that can be back-driven. | 1540.00 | 1832.60 |
| RAM-T1-12V |  Hydraulic Ram T1 12V High power, efficient drive units for maximum power with minimum consumption. Ram drives allow the Power Steer mode on the Pilot to be used in cases of manual steering failure. Fully Integrated hydraulic system, no external hoses, reservoirs etc. | 1700.00 | 2023.00 |
| RAM-T2-12V |  Hydraulic Ram T2 12V High power, efficient drive units for maximum power with minimum consumption. Ram drives allow the Power Steer mode on the Pilot to be used in cases of manual steering failure. Fully Integrated hydraulic system, no external hoses, reservoirs etc. | 2070.00 | 2463.30 |
| RAM-T2-24V |  Hydraulic Ram T2 24V High power, efficient drive units for maximum power with minimum consumption. Ram drives allow the Power Steer mode on the Pilot to be used in cases of manual steering failure. Fully Integrated hydraulic system, no external hoses, reservoirs etc. | 2070.00 | 2463.30 |
| 000-13788-001 |  Hydraulic Ram T3 12V Hydraulic Steering Systems combine a hydraulic cylinder with clutch, reversing pump and reservoir in a compact installation. | 2780.00 | 3308.20 |
| RAM-T3-24V |  Hydraulic Ram T3 24V Hydraulic Steering Systems combine a hydraulic cylinder with clutch, reversing pump and reservoir in a compact installation. | 2780.00 | 3308.20 |
| RAM-T4-24V |  Hydraulik Doppelzylinder mit Dauerläuferpumpe - Typ 4, 24 Volt | 8668.00 | 10314.92 |
| 21119896 |  DD15 Direct Drive unit for sailboats 30'-40' with electromagnetic clutch, lever with tiller pin and RF300 Rudder feedback. 12 V power supply (NAC-3 / H5000 required) | 2250.00 | 2677.50 |
| 000-13697-001 |  SD10 Mechanical Drive unit for NAC-2 Autopilot computers. The Dive will suit sailboats 25'-37' with 6' steering cable with electromagnetic clutch with override function, built in Rudder feedback and 12 V power supply | 1429.00 | 1700.51 |

Accessories

| Part Number | Description | RRP excl. (EUR) | RRP incl. (19.0%) |
|---------------|--------------------------------------------------------------------------------------------------------------------------------------------------------------------------------|-----------------|-------------------|
| 000-15944-001 |  Autopilot fitting adaptor kit. Contains 3 x ORB-5 to 1/4" NPT adaptors | 50.00 | 59.50 |
| 000-15949-001 |  ORB hose fitting kit for MKII Pumps 1, 2, 3, 4 & 5, including SteadySteer | 569.00 | 677.11 |
| 000-15942-001 |  Autopilot ORB hose fitting kit for MKII Pumps 1, 2, 3, 4 & 5 | 169.00 | 201.11 |



| Part Number | Description | RRP excl. (EUR) | RRP incl. (19.0%) |
|-------------|------------------------------------------------------------------------------------------------------------------------------------------------|-----------------|-------------------|
| 44172096 |  DL2030 Draglink for DD15. Length: 200-300 mm. 7.9" – 11.8" | 282.00 | 335.58 |
| 44172088 |  DL3040 Draglink for DD15. Length: 300-400 mm. 11.8" - 15.7". | 282.00 | 335.58 |
| 44172104 |  DL4050 Draglink for DD15. Length: 400-500 mm. 15.7" - 19.7". | 282.00 | 335.58 |

Spare Parts











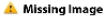

| Part Number | Description | RRP excl. (EUR) | RRP incl. (19.0%) |
|---------------|---------------------------------------------------------------------------------------------------------------------------------------------------------------------------------------|-----------------|-------------------|
| 20997953 |  RPU80/100/150/160/200 Seal Kit. Works for all motor types and pump sizes. | 97.00 | 115.43 |
| 20193744 |  RF300 Frequency Rudder Feedback - 10m cable and transmission link assembly. | 287.00 | 341.53 |
| 21118617 |  RPU80 Motor Brushes - Framco | 58.00 | 69.02 |
| 000-15858-001 |  PUMP-X Motor Brushes - Autopilot pump brush kit for PUMP-2,3,4 & 5. 2Pcs. Note: Not for Pump-1 | 65.00 | 77.35 |
| 000-13960-001 |  Brush replacements for RPU80, RPU160 and RPU300 pumps with Parvalux motors. | 83.00 | 98.77 |
| MOTOR-SPARE-1 |  Ersatzmotor für T1/T2-12V | 530.00 | 630.70 |
| RAM-BRSH-T2 |  Ersatz Bürsten für T3 und T4 Antriebe (Für T4 2 Satz erforderlich) | 56.00 | 66.64 |
| RAM-SPRS-T1 |  Ersatzteilsatz für RAM-T1-12V, RAM-T2-12V, RAM-T2-24V | 356.00 | 423.64 |
| RAM-SPRS-T3 |  Ersatzteilsatz für RAM-T3-24V | 512.00 | 609.28 |

Halo

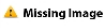
Main Products







| Part Number | Description | RRP excl. (EUR) | RRP incl. (19.0%) |
|---------------|--------------------------------------------------------------------------------------------------------------------------------------------------------------------------------------------------------------------------------------------------------------------------------------------------------------------------------------|-----------------|-------------------|
| 000-14540-001 |  HALO20 Radar - A cost-effective compact 20" Radar dome. 24nm range and 24RPM. The perfect radar solution for budget-conscious sailors with smaller vessels. | 2050.00 | 2439.50 |
| 000-14539-001 |  HALO20+ Radar - A compact 20" powerful 25W Solid-State Radar, delivering 60RPM at short range and up to 36nm range. Identify hazards in an instant with VelocityTrack™ Doppler technology and can run dual scale to identify hazards long and far. | 2410.00 | 2867.90 |
| 000-14538-001 |  HALO24 Radar - A 24" powerful 25W Solid-State Radar, delivering 60RPM at short range and up to 48nm range. Identify hazards in an instant with VelocityTrack™ Doppler technology and can run dual scale to identify hazards long and far. | 2700.00 | 3213.00 |

Accessories

| Part Number | Description | RRP excl. (EUR) | RRP incl. (19.0%) |
|---------------|------------------------------------------------------------------------------------------------------------------------------------------------------------------------------------|-----------------|-------------------|
| 000-12607-001 |  Precision-9 Compass - Outputs Heading, Rate Of Turn, Roll and Pitch over the NMEA 2000® network. | 669.00 | 796.11 |
| 000-11465-001 |  HALO Antenna Only - 4ft | 1295.83 | 1542.04 |
| 000-11466-001 |  HALO Antenna Only - 6ft | 1829.17 | 2176.71 |
| 000-11464-001 |  HALO Antenna Only - 3ft | 745.83 | 887.54 |
| 000-10795-001 |  SC20 Mast mount kit for HALO 20/20+ and Broadband Dome Radars. | 389.00 | 462.91 |
| 000-10904-001 |  Radar-Verlängerungskabel 2 m für Broadband Radarantennen | 66.00 | 78.54 |
| 000-14547-001 |  Power / Ethernet cable, 5 m (16.5 ft) for HALO dome radars and B&G Nemesis displays | 77.00 | 91.63 |
| 000-10905-001 |  Radar-Verlängerungskabel 5 m für Broadband Radarantennen | 77.00 | 91.63 |
| 000-14548-001 |  Power / Ethernet cable, 10 m (33 ft) for HALO dome radars and B&G Nemesis displays | 119.00 | 141.61 |
| 000-14551-001 |  Enables re-use of the existing BR24/3G/4G cable onboard when upgrading to a HALO Dome radar. | 65.00 | 77.35 |
| 000-14549-001 |  Power / Ethernet cable, 20 m (65.5 ft) for HALO dome radars and B&G Nemesis displays | 179.00 | 213.01 |
| 000-14550-001 |  Power / Ethernet cable, 30 m (98.5 ft) for HALO dome radars and B&G Nemesis displays | 239.00 | 284.41 |
| 000-11246-001 |  RJ45-Yellow Round Ethernet adapter cable RJ45 Male / 5 Pin Female 10 cm (6") | 24.00 | 28.56 |
| LMB-A1 |  LMB-A1 Selbstjustierende Radarhalterung zur rückwärtigen Backstagsmontage 3G/4G | 1725.00 | 2052.75 |



| Part Number | Description | RRP excl. (EUR) | RRP incl. (19.0%) |
|---------------|----------------------------------------------------------------------------------------------------------------------------------------------------------------------------------------------------------------------------------------------------------------------------------------------------------------------------------------------------------------------------------------------------------------------------------------------------------------------------------------------------------------------------------------------------------------------------------------------------------------------------------------------------------------------------------------------------------------------------------------------|-----------------|-------------------|
| 000-14072-001 |  <p>VelocityTrack™ technology provides instant visual feedback on the motion of moving radar targets in relation to your boat. This powerful add-on offers yet another way for Halo™ radar to improve your situational awareness and reduce your risk of collision. Using the Doppler effect, the VelocityTrack™ feature is able to detect motion on the first radar sweep for a useful view straight from standby. This feature is available for any new or existing Halo™ radar system via the purchase of a one-time unlock code.</p> <p>Radar system requires a heading sensor with 10 Hz output or greater. This needs to be connected to the RI12</p> | 551.00 | 655.69 |

Spare Parts











| Part Number | Description | RRP excl. (EUR) | RRP incl. (19.0%) |
|---------------|---------------------------------------------------------------------------------------------------------------------------------------------------------------------------------------------------------------------------------------------------------------------------------------------------------------------------------------------------------------|-----------------|-------------------|
| 000-11465-001 |  <p>HALO Antenna Only - 4ft</p> | 1295.83 | 1542.04 |
| 000-11466-001 |  <p>HALO Antenna Only - 6ft</p> | 1829.17 | 2176.71 |
| 000-14552-001 |  <p>Ethernet adapter cable, RJ45 F to 5 Pin male, 1.5 m (4.9 ft). Ships with water proof boot.</p> | 42.00 | 49.98 |
| 000-11464-001 |  <p>HALO Antenna Only - 3ft</p> | 745.83 | 887.54 |
| 000-12514-001 |  <p>HALO Pedestal, Spare mounting kit. Includes -4 x Bolt, HEX, M12x35, 316 s/s: -4 x Washer, Flat, M12x36x3, 316 s/s: -4 x Washer, Spring, M12, 316 s/s: -8 x Washer, Isolating M12x38 Nylon</p> | 66.00 | 78.54 |
| 000-12515-001 |  <p>HALO Antenna - Spare Mounting Kit. M8 Dome Nuts, M8 Spring Washers, M8x16x1.2 Flat Washers. 316 SS, 4pcs each.</p> | 41.00 | 48.79 |
| 000-11246-001 |  <p>RJ45-Yellow Round Ethernet adapter cable RJ45 Male / 5 Pin Female 10 cm (6")</p> | 24.00 | 28.56 |

Module

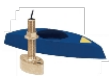
Main Products



| Part Number | Description | RRP excl. (EUR) | RRP incl. (19.0%) |
|---------------|-------------------------------------------------------------------------------------------------------------------------------------------------------------------------------------------------------------------------------------------------------------------------|-----------------|-------------------|
| 000-15918-001 |  S3100 High-performance sonar module. Two independent 1kW channels supporting 1 kW Low, Med, High, and High-Wide transducers. Support for high-frequency ActiveImaging HD transducers. | 899.00 | 1069.81 |
| 000-11142-001 |  SonarHub Module, with power cable and Ethernet cable 4.5m (15ft). Requires adapter 000-12571-001 or 000-13977-001 adapter cable to use Airmar Non-Chirp or Chirp 9-pin transducers. | 648.00 | 771.12 |
| 000-12397-001 |  StructureScan@ 3D module only. Transom mount and Through-Hull transducers available separately. | 648.00 | 771.12 |

Accessories

| Part Number | Description | RRP excl. (EUR) | RRP incl. (19.0%) |
|---------------|------------------------------------------------------------------------------------------------------------------------------------------------------------------------------------------------------------------------------------------------------|-----------------|-------------------|
| 000-11674-001 |  ForwardScan™ Transducer Kit with Sleeve & Plug. 10m (33ft) Cable | 769.00 | 915.11 |
| 000-13915-001 |  P319 - Plastic 600W Thru-Hull 50/200kHz Depth/Temperature. Black 9-pin connector and 10m (33ft) cable. | 169.00 | 201.11 |
| 000-14804-001 |  B744V - Bronze 600W Smart Thru Hull 50/200 KHz Depth/Temperature Transducer. 9pin sonar connector and 10m cable. NMEA2000 Speed/Temperature paddle wheel insert. | 669.00 | 796.11 |
| 000-13284-001 |  ForwardScan™ Transducer Kit (Long-Stem) with Sleeve & Plug. 10m (33ft) Cable | 1079.17 | 1284.21 |
| 000-13946-001 |  B45 - Bronze 600W Through-Hull 50/200 kHz Depth and Temperature transducer. Black 9 pin connector with 10m cable. (33ft) | 319.00 | 379.61 |
| 000-13784-001 |  SS60 (0°) - Stainless Steel 600 W Through-Hull 50/200 kHz Depth/Temperature Sonar Transducer. Black 9pin connector and 10m (33ft) cable. | 449.00 | 534.31 |
| 000-13785-001 |  SS60 (12°) - Stainless Steel 600 W Through-Hull 50/200 kHz Depth/Temperature Sonar Transducer. Black 9pin connector and 10m (33ft) cable. | 449.00 | 534.31 |
| 000-13786-001 |  SS60 (20°) - Stainless Steel 600 W Through-Hull 50/200 kHz Depth/Temperature Sonar Transducer. Black 9pin connector and 10m (33ft) cable. | 449.00 | 534.31 |
| 000-13942-001 |  P79 - Plastic 600 W In-Hull 50/200 kHz Depth Only. Black 9 pin connector with 10m cable. (33ft) | 149.00 | 177.31 |
| 000-13911-001 |  SS75H - Stainless Steel 600W Thru Hull High CHIRP (130-210kHz) Depth/Temperature Transducer. 9pin connector with 10m (33ft) cable. | 910.00 | 1082.90 |



| Part Number | Description | RRP excl. (EUR) | RRP incl. (19.0%) |
|---------------|-------------------------------------------------------------------------------------------------------------------------------------------------------------------------------------------------------------------------------------------------------------------------|-----------------|-------------------|
| 000-13912-001 |  SS75H - Stainless Steel 600W Thru Hull High CHIRP (130-210kHz) Depth/Temperature Transducer. 9pin connector with 10m (33ft) cable. | 910.00 | 1082.90 |
| 000-13913-001 |  SS75H - Stainless Steel 600W Thru Hull High CHIRP (130-210kHz) Depth/Temperature Transducer. 9pin connector with 10m (33ft) cable. | 899.00 | 1069.81 |
| 000-13908-001 |  SS75M - Stainless Steel 600W Thru Hull Medium-CHIRP (80-130kHz) Depth/Temperature Transducer. 9pin connector and 10m (33ft) cable. | 999.00 | 1188.81 |
| 000-13909-001 |  SS75M - Stainless Steel 600W Thru Hull Medium-CHIRP (80-130kHz) Depth/Temperature Transducer. 9pin connector and 10m (33ft) cable. | 999.00 | 1188.81 |
| 000-13910-001 |  SS75M - Stainless Steel 600W Thru Hull Medium-CHIRP (80-130kHz) Depth/Temperature Transducer. 9pin connector and 10m (33ft) cable. | 1019.00 | 1212.61 |
| 000-13916-001 |  SS164 (0°) - Stainless Steel 1kW Through-Hull 50/200 kHz Depth/Temperature Sonar Transducer. Black 9pin connector and 10m (33ft) cable. | 1349.00 | 1605.31 |
| 000-13917-001 |  SS164 (12°) - Stainless Steel 1kW Through-Hull 50/200 kHz Depth/Temperature Sonar Transducer. Black 9pin connector and 10m (33ft) cable. | 1349.00 | 1605.31 |
| 000-13918-001 |  SS164 (20°) - Stainless Steel 1kW Through-Hull 50/200 kHz Depth/Temperature Sonar Transducer. Black 9pin connector and 10m (33ft) cable. | 1349.00 | 1605.31 |
| 000-11460-001 |  Stainless steel StructureScan™ HD Sonar thru-hull transducer with Y-cable. (pair). Cable length 7.6 m (25 ft) | 1599.00 | 1902.81 |
| 000-13560-001 |  StructureScan 3D Dual Stainless Steel Thru-Hull Transducers. Cable length 7.6 m (25 ft) | 2644.00 | 3146.36 |
| 000-13977-001 |  Connects an XID Airmar CHIRP transducer with a 9 Pin black connector to the older 7 pin blue sockets on displays and echosounder modules. For use with Airmar 9pin XID transducers. | 32.99 | 39.26 |
| 000-10802-001 |  StructureScan™ HD Skimmer Heckmontagegeber 455/800 kHz | 309.99 | 368.89 |
| 000-00099-006 |  Extension cable for 9-pin transducers. *For optimum performance do not use more than 1 extension per installation. | 86.99 | 103.52 |

Spare Parts

| Part Number | Description | RRP excl. (EUR) | RRP incl. (19.0%) |
|---------------|--------------------------------------------------------------------------------------------------------------------------------------------|-----------------|-------------------|
| 000-0127-29 |  Ethernetkabel yellow 5 Pin 4.5 m (15 ft) | 56.00 | 66.64 |
| 000-00128-001 |  4-pin Power Cable for modules and MFDs. | 40.00 | 47.60 |
| 000-10802-001 |  StructureScan™ HD Skimmer Heckmontagegeber 455/800 kHz | 309.99 | 368.89 |

ForwardScan™







Main Products

| Part Number | Description | RRP excl. (EUR) | RRP incl. (19.0%) |
|---------------|----------------------------------------------------------------------------------------------------------------------------------------------------------------|--------------------|----------------------|
| 000-11674-001 |  ForwardScan™ Transducer Kit with Sleeve & Plug. 10m (33ft) Cable | 769.00 | 915.11 |
| 000-13284-001 |  ForwardScan™ Transducer Kit (Long-Stem) with Sleeve & Plug. 10m (33ft) Cable | 1079.17 | 1284.21 |

Accessories















| Part Number | Description | RRP excl. (EUR) | RRP incl. (19.0%) |
|---------------|------------------------------------------------------------------------------------------------------------------------------------------------------------------------------------------------------|--------------------|----------------------|
| 000-00099-006 |  Extension cable for 9-pin transducers. *For optimum performance do not use more than 1 extension per installation. | 86.99 | 103.52 |





Spare Parts

| Part Number | Description | RRP excl. (EUR) | RRP incl. (19.0%) |
|---------------|--------------------------------------------------------------------------------------------------------------------------------------------------------|--------------------|----------------------|
| 000-11669-001 |  ForwardScan™ Sleeve and Plug Only (No Transducer) | 218.99 | 260.60 |
| 000-12231-001 |  ForwardScan™ Fairing Block Only | 43.99 | 52.35 |
| 000-12230-001 |  ForwardScan™ Plug Only | 30.85 | 36.71 |
| 000-12232-001 |  ForwardScan™ O-Ring (Color of supplied O-Ring may vary from shown) | 6.49 | 7.72 |
| 000-11675-001 |  ForwardScan™ Transducer Only. With 10m (33ft) Cable | 550.00 | 654.50 |
| 000-13578-001 |  ForwardScan™ Long-Stem Housing Only | 207.99 | 247.51 |
| 000-13579-001 | ForwardScan™ Long-Stem Fairing Block Only | 53.99 | 64.25 |



Transducer

Main Products

| Part Number | Description | RRP excl. (EUR) | RRP incl. (19.0%) |
|---------------|----------------------------------------------------------------------------------------------------------------------------------------------------------------------------------------------------------------------------------------------------|-----------------|-------------------|
| 000-13915-001 |  P319 - Plastic 600W Thru-Hull 50/200kHz Depth/Temperature. Black 9-pin connector and 10m (33ft) cable. | 169.00 | 201.11 |
| 000-14804-001 |  B744V - Bronze 600W Smart Thru Hull 50/200 Khz Depth/Temperature Transducer. 9pin sonar connector and 10m cable. NMEA2000 Speed/Temperature paddle wheel insert. | 669.00 | 796.11 |
| 000-13946-001 |  B45 - Bronze 600W Through-Hull 50/200 kHz Depth and Temperature transducer. Black 9 pin connector with 10m cable. (33ft) | 319.00 | 379.61 |
| 000-13784-001 |  SS60 (0°) - Stainless Steel 600 W Through-Hull 50/200 kHz Depth/Temperature Sonar Transducer. Black 9pin connector and 10m (33ft) cable. | 449.00 | 534.31 |
| 000-13785-001 |  SS60 (12°) - Stainless Steel 600 W Through-Hull 50/200 kHz Depth/Temperature Sonar Transducer. Black 9pin connector and 10m (33ft) cable. | 449.00 | 534.31 |
| 000-13786-001 |  SS60 (20°) - Stainless Steel 600 W Through-Hull 50/200 kHz Depth/Temperature Sonar Transducer. Black 9pin connector and 10m (33ft) cable. | 449.00 | 534.31 |
| 000-13942-001 |  P79 - Plastic 600 W In-Hull 50/200 kHz Depth Only. Black 9 pin connector with 10m cable. (33ft) | 149.00 | 177.31 |
| 000-13911-001 |  SS75H - Stainless Steel 600W Thru Hull High CHIRP (130-210kHz) Depth/Temperature Transducer. 9pin connector with 10m (33ft) cable. | 910.00 | 1082.90 |
| 000-13912-001 |  SS75H - Stainless Steel 600W Thru Hull High CHIRP (130-210kHz) Depth/Temperature Transducer. 9pin connector with 10m (33ft) cable. | 910.00 | 1082.90 |
| 000-13913-001 |  SS75H - Stainless Steel 600W Thru Hull High CHIRP (130-210kHz) Depth/Temperature Transducer. 9pin connector with 10m (33ft) cable. | 899.00 | 1069.81 |
| 000-13908-001 |  SS75M - Stainless Steel 600W Thru Hull Medium-CHIRP (80-130kHz) Depth/Temperature Transducer. 9pin connector and 10m (33ft) cable. | 999.00 | 1188.81 |
| 000-13909-001 |  SS75M - Stainless Steel 600W Thru Hull Medium-CHIRP (80-130kHz) Depth/Temperature Transducer. 9pin connector and 10m (33ft) cable. | 999.00 | 1188.81 |
| 000-13910-001 |  SS75M - Stainless Steel 600W Thru Hull Medium-CHIRP (80-130kHz) Depth/Temperature Transducer. 9pin connector and 10m (33ft) cable. | 1019.00 | 1212.61 |
| 000-13916-001 |  SS164 (0°) - Stainless Steel 1kW Through-Hull 50/200 kHz Depth/Temperature Sonar Transducer. Black 9pin connector and 10m (33ft) cable. | 1349.00 | 1605.31 |
| 000-13917-001 |  SS164 (12°) - Stainless Steel 1kW Through-Hull 50/200 kHz Depth/Temperature Sonar Transducer. Black 9pin connector and 10m (33ft) cable. | 1349.00 | 1605.31 |





| Part Number | Description | RRP excl. (EUR) | RRP incl. (19.0%) |
|---------------|-----------------------------------------------------------------------------------------------------------------------------------------------------------------------------------------------------------------------------------------------------------------------|-----------------|-------------------|
| 000-13918-001 |  SS164 (20°) - Stainless Steel 1kW Through-Hull 50/200 kHz Depth/Temperature Sonar Transducer. Black 9pin connector and 10m (33ft) cable. | 1349.00 | 1605.31 |
| 000-11460-001 |  Stainless steel StructureScan™ HD Sonar thru-hull transducer with Y-cable. (pair). Cable length 7.6 m (25 ft) | 1599.00 | 1902.81 |
| 000-13560-001 |  StructureScan 3D Dual Stainless Steel Thru-Hull Transducers. Cable length 7.6 m (25 ft) | 2644.00 | 3146.36 |
| 000-13977-001 |  Connects an XID Airmar CHIRP transducer with a 9 Pin black connector to the older 7 pin blue sockets on displays and echosounder modules. For use with Airmar 9pin XID transducers. | 32.99 | 39.26 |

Accessories









| Part Number | Description | RRP excl. (EUR) | RRP incl. (19.0%) |
|---------------|-----------------------------------------------------------------------------------------------------------------------------------------------------------------------------------------------------------------------------------------------------------------------|-----------------|-------------------|
| 000-16295-001 | TRANSDUCER/NETWORK CABLE PULLING TOOLS | 24.99 | 29.74 |
| 000-13977-001 |  Connects an XID Airmar CHIRP transducer with a 9 Pin black connector to the older 7 pin blue sockets on displays and echosounder modules. For use with Airmar 9pin XID transducers. | 32.99 | 39.26 |
| 000-00099-006 |  Extension cable for 9-pin transducers. *For optimum performance do not use more than 1 extension per installation. | 86.99 | 103.52 |











V100

Main Products





| Part Number | Description | RRP excl. (EUR) | RRP incl. (19.0%) |
|---------------|-----------------------------------------------------------------------------------------------------------------------------------------------------------------------------------------------------------------------------------------------------------------------------------------------------------------------------------------------------------|-----------------|-------------------|
| 000-15793-001 |  B&G V100-B Blackbox VHF Radio System - featuring a built-in GPS and Class B AIS transceiver, which allows you to see and be seen by AIS-equipped vessels. Stay connected from anywhere on board with up to 8 handsets (4 wired and 4 wireless) and 4 external speakers. | 1574.00 | 1873.06 |
| 000-15644-001 |  B&G V100 Blackbox VHF Radio System - Stay safer on the water with the B&G V100 VHF marine radio. With up to 8 connected handsets (4 wired and 4 wireless) and 4 external speakers, stay connected from anywhere on board. | 940.00 | 1118.60 |
| 000-15648-001 |  B&G H100 wired handset and speaker for V100/V100-B VHF radios. Up to 4 wired handsets can be added to one system and 4 wired Speakers. | 373.00 | 443.87 |
| 000-15650-001 |  B&G H100 wired handset for V100/V100-B VHF radios. Up to 4 wired handsets can be added to one system. | 309.00 | 367.71 |
| 000-15651-001 |  SP100: External VHF speaker. 10W @ 4 Ohms. Comes with an attached twin core 2 m (6.5 ft) cable. | 95.00 | 113.05 |

Accessories

| Part Number | Description | RRP excl. (EUR) | RRP incl. (19.0%) |
|---------------|----------------------------------------------------------------------------------------------------------------------------------------------------------------------------------------------------------------------------------------------------------------------------------------------------------------------------------------------------------------|-----------------|-------------------|
| 000-16055-001 |  VHF antenna mount. Heavy-duty stainless steel fold-down antenna mount. With attached 7 m (23 ft) cable. Fastfit connector | 83.50 | 99.37 |
| 000-15648-001 |  B&G H100 wired handset and speaker for V100/V100-B VHF radios. Up to 4 wired handsets can be added to one system and 4 wired Speakers. | 373.00 | 443.87 |
| 000-15650-001 |  B&G H100 wired handset for V100/V100-B VHF radios. Up to 4 wired handsets can be added to one system. | 309.00 | 367.71 |
| 000-13612-001 |  NSPL-500 AIS/VHF Antenna Splitter - Enables use of one VHF antenna on the vessel for both VHF and AIS. | 269.00 | 320.11 |
| 000-14476-001 |  B&G H60 Wireless Handset - Take remote control of your B&G V60 VHF radio, and enjoy the power of a fixed-mount system with the convenience of a handheld. Easily carried and simple to use, this wireless handset gives you total freedom of movement on board your yacht. | 249.00 | 296.31 |
| 000-15651-001 |  SP100: External VHF speaker. 10W @ 4 Ohms. Comes with an attached twin core 2 m (6.5 ft) cable. | 95.00 | 113.05 |
| 000-14924-001 |  10m Extension Cable for RS40, RS40-B, V60, V60B and Link-9 VHF Fist Mics, and H100/HS100 Handsets. | 55.00 | 65.45 |
| 000-13613-001 |  GPS-500 - GPS antenna for Navico AIS transceivers and VHF systems. 10 m (33 ft) cable with SMA connector. | 149.00 | 177.31 |
| 000-14968-001 |  Navico 1710 VHF antenna, 2.5 m (8 ft) ultraglass, quickfit @ 6dB BLACK | 88.00 | 104.72 |





| Part Number | Description | RRP excl. (EUR) | RRP incl. (19.0%) |
|---------------|--------------------------------------------------------------------------------------------------------------------------------------------------------------------------------------------------------------------------------------------------------|-----------------|-------------------|
| 000-15657-001 |  NRS-1/ NRS-2 Bulkhead WiFi Antenna Mount Cable - 6m - For mounting the WiFi antenna in more suitable location if reception from antenna on Blackbox is not adequate. | 129.00 | 153.51 |
| 000-15656-001 |  HS100/H100 Handset cable with bulkhead mount 20m (65.5 ft) | 109.00 | 129.71 |
| AA000355 |  UKW-Antenne Gfk 240 cm | 75.00 | 89.25 |
| AA000358 |  UKW-Antenne Gfk 100 cm | 41.00 | 48.79 |
| AA000223 |  Antennenhalterung Kunststoff mit 5 m Kabel | 36.00 | 42.84 |
| AA000224 |  Antennenhalterung Edelstahl mit 5 m Kabel | 73.00 | 86.87 |
| AA000352 |  UKW-Antenne Mastmontage | 52.00 | 61.88 |
| AA000400 |  VHF extension cable 5 m (16 ft) | 29.00 | 34.51 |
| AA000401 |  VHF mast cable 30 m (98 ft) for 1720 whip antenna. With Quick Fit Connector one end and Masthead connector on the other. | 70.00 | 83.30 |
| 000-15859-001 |  VHF ANTENNA, 1Meter Back Fiberglass Stainless Steel, Quick fit fitting. | 78.00 | 92.82 |

Spare Parts









| Part Number | Description | RRP excl. (EUR) | RRP incl. (19.0%) |
|---------------|-----------------------------------------------------------------------------------------------------------------------------------------------------------------------------------------------|-----------------|-------------------|
| 000-15650-001 |  B&G H100 wired handset for V100/V100-B VHF radios. Up to 4 wired handsets can be added to one system. | 309.00 | 367.71 |
| 000-15651-001 |  SP100: External VHF speaker. 10W @ 4 Ohms. Comes with an attached twin core 2 m (6.5 ft) cable. | 95.00 | 113.05 |
| 000-13613-001 |  GPS-500 - GPS antenna for Navico AIS transceivers and VHF systems. 10 m (33 ft) cable with SMA connector. | 149.00 | 177.31 |
| 000-15642-001 |  NRS-2 Marine VHF Radio with built in AIS Class B transceiver. Black box only | 1339.00 | 1593.41 |
| 000-15641-001 |  NRS-1 Marine VHF Radio. Black box only | 749.00 | 891.31 |









V60

Main Products







| Part Number | Description | RRP excl. (EUR) | RRP incl. (19.0%) |
|---------------|---------------------------------------------------------------------------------------------------------------------------------------------------------------------------------------------------------------------------------------------------------------------------------------------------------------------------------------------------------------------------------------------------------|-----------------|-------------------|
| 000-14471-001 |  B&G V60 fixed-mount DSC VHF Radio - Stay safe and connected with this VHF marine radio featuring a sleek design with removable fist mic, Class D DSC functionality, and built-in GPS. | 539.00 | 641.41 |
| 000-14474-001 |  B&G V60-B Marine VHF Radio - Stay safer on the water with this VHF marine radio featuring a built-in GPS and a full Class B AIS transmitter and receiver, which allows you to see and be seen by nearby AIS-equipped vessels. | 1049.00 | 1248.31 |
| 000-14819-001 |  B&G V60-B Marine VHF Radio - Stay safer on the water with this VHF marine radio featuring a built-in GPS and a full Class B AIS transmitter and receiver, which allows you to see and be seen by nearby AIS-equipped vessels. Includes GPS-500 GPS antenna for situations where the internal GPS don't get reception. | 1149.00 | 1367.31 |
| 000-14476-001 |  B&G H60 Wireless Handset - Take remote control of your B&G V60 VHF radio, and enjoy the power of a fixed-mount system with the convenience of a handheld. Easily carried and simple to use, this wireless handset gives you total freedom of movement on board your yacht. | 249.00 | 296.31 |

Accessories

| Part Number | Description | RRP excl. (EUR) | RRP incl. (19.0%) |
|---------------|----------------------------------------------------------------------------------------------------------------------------------------------------------------------------------------------------------------------------------------------------------------------------------------------------------------------------------------------------------------|-----------------|-------------------|
| 000-16055-001 |  VHF antenna mount. Heavy-duty stainless steel fold-down antenna mount. With attached 7 m (23 ft) cable. Fastfit connector | 83.50 | 99.37 |
| 000-14476-001 |  B&G H60 Wireless Handset - Take remote control of your B&G V60 VHF radio, and enjoy the power of a fixed-mount system with the convenience of a handheld. Easily carried and simple to use, this wireless handset gives you total freedom of movement on board your yacht. | 249.00 | 296.31 |
| 000-13612-001 |  NSPL-500 AIS/VHF Antenna Splitter - Enables use of one VHF antenna on the vessel for both VHF and AIS. | 269.00 | 320.11 |
| 000-15651-001 |  SP100: External VHF speaker. 10W @ 4 Ohms. Comes with an attached twin core 2 m (6.5 ft) cable. | 95.00 | 113.05 |
| 000-14923-001 |  5m Extension Cable for RS40, RS40-B, V60, V60B and Link-9 VHF Fist Mics, and H100/HS100 Handsets. | 44.00 | 52.36 |
| 000-14924-001 |  10m Extension Cable for RS40, RS40-B, V60, V60B and Link-9 VHF Fist Mics, and H100/HS100 Handsets. | 55.00 | 65.45 |
| 000-13613-001 |  GPS-500 - GPS antenna for Navico AIS transceivers and VHF systems. 10 m (33 ft) cable with SMA connector. | 149.00 | 177.31 |
| 000-14968-001 |  Navico 1710 VHF antenna, 2.5 m (8 ft) ultraglass, quickfit @ 6dB BLACK | 88.00 | 104.72 |
| AA000355 |  UKW-Antenne Gfk 240 cm | 75.00 | 89.25 |

| Part Number | Description | RRP excl. (EUR) | RRP incl. (19.0%) |
|---------------|------------------------------------------------------------------------------------------------------------------------------------------------------------------------------------------------------------|-----------------|-------------------|
| AA000358 |  UKW-Antenne Gfk 100 cm | 41.00 | 48.79 |
| AA000223 |  Antennenhalterung Kunststoff mit 5 m Kabel | 36.00 | 42.84 |
| AA000224 |  Antennenhalterung Edelstahl mit 5 m Kabel | 73.00 | 86.87 |
| AA000352 |  UKW-Antenne Mastmontage | 52.00 | 61.88 |
| AA000400 |  VHF extension cable 5 m (16 ft) | 29.00 | 34.51 |
| AA000401 |  VHF mast cable 30 m (98 ft) for 1720 whip antenna. With Quick Fit Connector one end and Masthead connector on the other. | 70.00 | 83.30 |
| 000-10378-001 |  VKIT-9 Einbausatz für versenkten Einbau RS10, RS12 und RS25 | 10.58 | 12.59 |
| 000-15859-001 |  VHF ANTENNA, 1 Meter Back Fiberglass Stainless Steel, Quick fit fitting. | 78.00 | 92.82 |
| 000-14066-001 |  VHF Interface - Type 6. For Simrad RS20/RS40, B&G V20/V60 | 88.00 | 104.72 |

Spare Parts













| Part Number | Description | RRP excl. (EUR) | RRP incl. (19.0%) |
|---------------|-----------------------------------------------------------------------------------------------------------------------------------------------------------------------------------------------------------------------------------------------------------------------|-----------------|-------------------|
| 000-14913-001 |  V60 VHF Suncover | 22.00 | 26.18 |
| 000-14922-001 |  B&G V60 Remote Mountable Fist Mic. Can be connected to the front or rear of the radio, and optional extension cable allows the radio and mic to be mounted in separate locations. | 77.00 | 91.63 |
| 000-14919-001 |  RS40/V60 Bulkhead Fist Mic Mounting Clip | 9.00 | 10.71 |
| 000-14917-001 |  RS40/V60 VHF Mounting bracket with Knobs and Screws | 27.00 | 32.13 |
| 000-14915-001 |  RS40/V60 VHF Flush Mounting kit.:Includes teplate, Gasket, Bezels and screws | 12.00 | 14.28 |
| 000-14925-001 |  HS40/H60 VHF Wireless handset Inductive charging cradle | 55.00 | 65.45 |

V20

Main Products



| Part Number | Description | RRP excl. (EUR) | RRP incl. (19.0%) |
|---------------|-------------------------------------------------------------------------------------------------------------------------------------------------------------------------------------------------------------------------------------------------------------------------------------------------------------------|-----------------|-------------------|
| 000-14492-001 |  B&G V20S Class D DSC VHF Radio - The versatile V20S is ideal for a variety of boats from small yachts to larger cruisers and racing boats, and is designed to match the low-profile style of our chartplotters and accessories. | 334.00 | 397.46 |

Accessories

| Part Number | Description | RRP excl. (EUR) | RRP incl. (19.0%) |
|---------------|-------------------------------------------------------------------------------------------------------------------------------------------------------------------------------------------------------------|-----------------|-------------------|
| 000-16055-001 |  VHF antenna mount. Heavy-duty stainless steel fold-down antenna mount. With attached 7 m (23 ft) cable. Fastfit connector | 83.50 | 99.37 |
| 000-14968-001 |  Navico 1710 VHF antenna, 2.5 m (8 ft) ultraglass, quickfit @ 6dB BLACK | 88.00 | 104.72 |
| AA000355 |  UKW-Antenne Gfk 240 cm | 75.00 | 89.25 |
| AA000358 |  UKW-Antenne Gfk 100 cm | 41.00 | 48.79 |
| AA000223 |  Antennenhalterung Kunststoff mit 5 m Kabel | 36.00 | 42.84 |
| AA000224 |  Antennenhalterung Edelstahl mit 5 m Kabel | 73.00 | 86.87 |
| AA000352 |  UKW-Antenne Mastmontage | 52.00 | 61.88 |
| AA000400 |  VHF extension cable 5 m (16 ft) | 29.00 | 34.51 |
| 000-15859-001 |  VHF ANTENNA, 1 Meter Back Fiberglass Stainless Steel, Quick fit fitting. | 78.00 | 92.82 |
| 000-14056-001 |  V20 Suncover | 20.59 | 24.50 |
| 000-14066-001 |  VHF Interface - Type 6. For Simrad RS20/RS40, B&G V20/V60 | 88.00 | 104.72 |
| 000-14059-001 |  RS20/V20 Flush Mount Kit | 12.00 | 14.28 |





Spare Parts

| Part Number | Description | RRP excl. (EUR) | RRP incl. (19.0%) |
|---------------|---------------------------------------------------------------------------------------------------------------|-----------------|-------------------|
| 000-14261-001 |  RS20/V20 Mounting Bracket | 33.00 | 39.27 |











| Part Number | Description | RRP excl. (EUR) | RRP incl. (19.0%) |
|---------------|-------------------------------------------------------------------------------------------------------------------|--------------------|----------------------|
| 000-14263-001 |  RS20/V20 Mounting Bracket Knobs | 16.00 | 19.04 |
| 000-14056-001 |  V20 Suncover | 20.59 | 24.50 |
| 000-14262-001 |  RS20/V20 Fist Mic Clip | 9.00 | 10.71 |

Class B





Main Products

| Part Number | Description | RRP excl. (EUR) | RRP incl. (19.0%) |
|---------------|--------------------------------------------------------------------------------------------------------------------------------------------------------------------------------------------------------------------------------------------------------------------------------------------------------------------------------------------------------------------------|-----------------|-------------------|
| 000-14380-001 |  The V3100 Class B AIS incorporates SOTDMA technology and increased transmission power to enhance transmission frequency, reliability, and range compared to standard Class B AIS. This 'black-box' solution integrates with MFD displays, and features industry-standard connectivity. | 935.00 | 1112.65 |
| 000-13963-001 |  NAIS-500 Class B AIS including NSPL500 VHF/AIS Antenna splitter and GPS500 antenna. Broadcast your location to anyone nearby with an AIS Receiver. A low cost safety system for recreational vessels and smaller professional vessels in near coastal waters. | 1099.00 | 1307.81 |
| 000-13609-001 |  NAIS-500 class B AIS with GPS-500 GPS antenna. Broadcast your location to anyone nearby with an AIS Receiver. A low cost safety system for recreational vessels and smaller professional vessels in near coastal waters. | 829.00 | 986.51 |
| 000-13612-001 |  NSPL-500 AIS/VHF Antenna Splitter - Enables use of one VHF antenna on the vessel for both VHF and AIS. | 269.00 | 320.11 |

Accessories

| Part Number | Description | RRP excl. (EUR) | RRP incl. (19.0%) |
|---------------|--------------------------------------------------------------------------------------------------------------------------------------------------------------------------------------------------------------|-----------------|-------------------|
| 000-16055-001 |  VHF antenna mount. Heavy-duty stainless steel fold-down antenna mount. With attached 7 m (23 ft) cable. Fastfit connector | 83.50 | 99.37 |
| 000-13612-001 |  NSPL-500 AIS/VHF Antenna Splitter - Enables use of one VHF antenna on the vessel for both VHF and AIS. | 269.00 | 320.11 |
| 000-14968-001 |  Navico 1710 VHF antenna, 2.5 m (8 ft) ultraglass, quickfit @ 6dB BLACK | 88.00 | 104.72 |
| AA000355 |  UKW-Antenne Gfk 240 cm | 75.00 | 89.25 |
| AA000358 |  UKW-Antenne Gfk 100 cm | 41.00 | 48.79 |
| AA000223 |  Antennenhalterung Kunststoff mit 5 m Kabel | 36.00 | 42.84 |
| AA000224 |  Antennenhalterung Edelstahl mit 5 m Kabel | 73.00 | 86.87 |
| AA000352 |  UKW-Antenne Mastmontage | 52.00 | 61.88 |
| AA000400 |  VHF extension cable 5 m (16 ft) | 29.00 | 34.51 |
| AA000401 |  VHF mast cable 30 m (98 ft) for 1720 whip antenna. With Quick Fit Connector one end and Masthead connector on the other. | 70.00 | 83.30 |
| 000-15859-001 |  VHF ANTENNA, 1Meter Back Fiberglass Stainless Steel, Quick fit fitting. | 78.00 | 92.82 |

Spare Parts

| Part Number | Description | RRP excl. (EUR) | RRP incl. (19.0%) |
|---------------|-----------------------------------------------------------------------------------------------------------------------------------------------------------------------------------------------------------------------------------------------------------------------------------------------|--------------------|----------------------|
| 000-13959-001 |  NAIS500/400 & Naviop OP-BOX Power & Serial Cable | 59.00 | 70.21 |
| 000-13613-001 |  GPS-500 - GPS antenna for Navico AIS transceivers and VHF systems. 10 m (33 ft) cable with SMA connector. | 149.00 | 177.31 |
| 000-14806-001 |  V3100 Power cable, 1.8 m (6ft) | 32.00 | 38.08 |
| 000-14807-001 |  V3100 NMEA 0183 Cable 1.8 m (6ft) | 32.00 | 38.08 |
| 000-13611-001 |  NAIS-500 class B AIS module only. Broadcast your location to anyone nearby with an AIS Receiver. A low cost safety system for recreational vessels and smaller professional vessels in near coastal waters. | 789.00 | 938.91 |

Cameras

Main Products















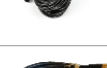

| Part Number | Description | RRP excl. (EUR) | RRP incl. (19.0%) |
|---------------|-----------------------------------------------------------------------------------------------------------------------------------------------------------------------------|-----------------|-------------------|
| 000-15876-001 |  <p>The IP CAM-1 marine grade 316 stainless steel IP camera. Powered by 12V DC or PoE.</p> | 559.00 | 665.21 |







Accessories

| Part Number | Description | RRP excl. (EUR) | RRP incl. (19.0%) |
|---------------|-------------------------------------------------------------------------------------------------------------------------------------------------------------------------------------|-----------------|-------------------|
| 000-14552-001 |  <p>Ethernet adapter cable, RJ45 F to 5 Pin male, 1.5 m (4.9 ft). Ships with water proof boot.</p> | 42.00 | 49.98 |





Micro-C

Main Products





| Part Number | Description | RRP excl. (EUR) | RRP incl. (19.0%) |
|---------------|--------------------------------------------------------------------------------------------------------------------------------------------------------------------------------------------------------------------------------------------------------------------------------------------|-----------------|-------------------|
| 000-10760-001 |  NMEA 2000 Micro-C Auto pilot network starter kit: Includes Network power cable, 4.5 m (15 ft) N2K cable, 3 x T-connectors, and 2 x network terminators. | 90.00 | 107.10 |
| 000-0119-79 |  N2K-T-RD - NMEA 2000® T-connector zur Netzwerkerweiterung | 22.00 | 26.18 |
| 000-12612-001 |  Low loss NMEA2000 4-way joiner. Connect four NMEA2000 Micro-C devices to the NMEA2000 Network. | 54.00 | 64.26 |
| 000-0119-88 |  N2KEXT-2RD - 0.61 m (2-ft) NMEA 2000® Netzwerkkabel | 32.00 | 38.08 |
| 000-0127-53 |  N2KEXT-6RD - 1.82 m (6-ft) NMEA 2000® Netzwerkkabel | 50.00 | 59.50 |
| 000-0119-86 |  N2KEXT-15RD - 4.55 m (15-ft) NMEA 2000® Netzwerkkabel | 56.00 | 66.64 |
| 000-0119-83 |  N2KEXT-25RD - 7.58 m (25-ft) NMEA 2000® Netzwerkkabel | 79.00 | 94.01 |
| 000-14376-001 |  NMEA 2000 Micro-C Medium duty cable. 2 m (6.5 ft) Low loss 18 gauge cable recommended for network backbone runs | 63.00 | 74.97 |
| 000-14377-001 |  NMEA 2000 Micro-C Medium duty cable. 6 m (19.7 ft) Low loss 18 gauge cable recommended for network backbone runs | 71.00 | 84.49 |
| 000-14378-001 |  NMEA 2000 Micro-C Medium duty cable. 10 m (33 ft) Low loss 18 gauge cable recommended for network backbone runs | 99.00 | 117.81 |
| 000-14379-001 |  NMEA 2000 Micro-C Medium duty cable. 20 m (65.6 ft) Low loss 18-gauge cable recommended for network backbone runs resulting in a more robust network. Cables are identified by orange locking collars. | 119.00 | 141.61 |
| 000-10614-001 |  N2K, IS40 CABLE, MICRO-C, RIGHT ANGLE INTERCONNECT 0.4m (1.3 ft) | 24.00 | 28.56 |
| 000-15739-001 |  NMEA 2000 cable 0.6 m (2 ft) Micro-C straight connector / 90 degree female connector. | 34.00 | 40.46 |
| 000-10403-001 |  T-Joiner, Micro-C, Metal | 36.26 | 43.14 |
| 000-10396-001 |  Kabel, MICRO-C, Metal, 0.4 m | 29.46 | 35.06 |
| 000-0127-52 |  TR-120-KIT - Set (2Stück) NMEA 2000® Abschlusswiderstände | 22.00 | 26.18 |
| 000-0119-75 |  N2K-PWR-RD - NMEA 2000® Power Note (Kabel und T-Verbinder) zum erweitern von älteren Lowrance Geräten ans HDS | 60.51 | 72.01 |
| 000-10828-001 |  CZONE™ Network Bridge Interface - Designed to isolate sections of the NMEA 2000 network to decrease standby current draw. Can be used for Isolation when bridging between two CAN networks. | 329.00 | 391.51 |

| Part Number | Description | RRP excl. (EUR) | RRP incl. (19.0%) |
|---------------|-----------------------------------------------------------------------------------------------------------------------------------------------------------------------------------------------------|-----------------|-------------------|
| 000-12259-001 |  Network power isolator. Separates separately powered sections of the NMEA2000 network while letting data through. | 40.00 | 47.60 |
| 000-15939-001 |  NMEA 0183® - NMEA 2000® converter. 1.8 m (6 ft) Micro-C to bare wire cable | 183.00 | 217.77 |
| 000-0127-45 |  SimNet auf N2K Adapter-Kit - verbindet SimNet-Komponenten mit NMEA 2000® Netzwerk | 118.51 | 141.03 |
| 24005729 |  SimNet to Micro-C (male) cable that connects a SimNet product to a NMEA 2000® backbone. 0.5 m (1.6 ft) | 38.00 | 45.22 |
| 000-10757-001 |  Kabel 20 m (66 ft) NMEA2000 Wind-Masteinheit (Micro-C male - Simnet) | 96.00 | 114.24 |
| 000-10758-001 |  Kabel 35 m (66 ft) NMEA2000 Wind-Masteinheit (Micro-C male - Simnet) | 133.00 | 158.27 |

Accessories









| Part Number | Description | RRP excl. (EUR) | RRP incl. (19.0%) |
|-------------|--------------------------------------------------------------------------------------------------------------------------------------------------------------------------------------------|-----------------|-------------------|
| 000-0119-88 |  N2KEXT-2RD - 0.61 m (2-ft) NMEA 2000® Netzwerkkabel | 32.00 | 38.08 |
| 000-0127-53 |  N2KEXT-6RD - 1.82 m (6-ft) NMEA 2000® Netzwerkkabel | 50.00 | 59.50 |
| 000-0119-86 |  N2KEXT-15RD - 4.55 m (15-ft) NMEA 2000® Netzwerkkabel | 56.00 | 66.64 |
| 24005729 |  SimNet to Micro-C (male) cable that connects a SimNet product to a NMEA 2000® backbone. 0.5 m (1.6 ft) | 38.00 | 45.22 |

Spare Parts





| Part Number | Description | RRP excl. (EUR) | RRP incl. (19.0%) |
|---------------|--------------------------------------------------------------------------------------------------------------------------------------------------------------------------------------------------|-----------------|-------------------|
| 44172260 |  SimNet joiner yellow without terminator | 18.00 | 21.42 |
| 000-13714-001 |  Networked wind sensor for Triton2, Triton, IS42, IS40 and IS20 systems. Sensor only, does not include cable. | 430.00 | 511.70 |
| 000-10573-001 |  IS20 Windfahnen Masthalterung | 65.92 | 78.44 |
| 24005729 |  SimNet to Micro-C (male) cable that connects a SimNet product to a NMEA 2000® backbone. 0.5 m (1.6 ft) | 38.00 | 45.22 |

Ethernet

Main Products

| Part Number | Description | RRP excl. (EUR) | RRP incl. (19.0%) |
|---------------|------------------------------------------------------------------------------------------------------------------------------------------------------------------------------|-----------------|-------------------|
| 000-16144-001 | Ethernet Cable -Yellow 5-Pin Male-Male - 0.6 m (2 ft) | 24.99 | 29.74 |
| 000-14552-001 |  Ethernet adapter cable, RJ45 F to 5 Pin male, 1.5 m (4.9 ft). Ships with water proof boot. | 42.00 | 49.98 |
| 000-0127-56 |  Adapter cable: Ethernet yellow 5 pin male to RJ45 female, 2m (6.5ft) | 42.00 | 49.98 |
| 000-10029-001 |  NEP-2 Network Expansion Port (Ethernetverteiler mit 5 Ports) | 309.00 | 367.71 |
| 000-0127-51 |  Ethernetkabel yellow 5 Pin 1.8 m (6 ft) | 38.00 | 45.22 |
| 000-0127-29 |  Ethernetkabel yellow 5 Pin 4.5 m (15 ft) | 56.00 | 66.64 |
| 000-0127-30 |  Ethernetkabel yellow 5 Pin 7.7 m (25 ft) | 79.00 | 94.01 |
| 000-0127-37 |  Ethernetkabel yellow 5 Pin 15.2 m (50 ft) | 109.00 | 129.71 |
| 000-11246-001 |  RJ45-Yellow Round Ethernet adapter cable RJ45 Male / 5 Pin Female 10 cm (6") | 24.00 | 28.56 |

Accessories

| Part Number | Description | RRP excl. (EUR) | RRP incl. (19.0%) |
|-------------|-------------------------------------------------------------------------------------------------------------------------------|-----------------|-------------------|
| 000-0127-51 |  Ethernetkabel yellow 5 Pin 1.8 m (6 ft) | 38.00 | 45.22 |
| 000-0127-29 |  Ethernetkabel yellow 5 Pin 4.5 m (15 ft) | 56.00 | 66.64 |
| 000-0127-30 |  Ethernetkabel yellow 5 Pin 7.7 m (25 ft) | 79.00 | 94.01 |
| 000-0127-37 |  Ethernetkabel yellow 5 Pin 15.2 m (50 ft) | 109.00 | 129.71 |

Spare Parts

| Part Number | Description | RRP excl. (EUR) | RRP incl. (19.0%) |
|---------------|---------------------------------------------------------------------------------------------------------------|-----------------|-------------------|
| 000-11447-001 |  Spare WIFI-1 Power Cable. | 30.90 | 36.77 |

| Part Number | Description | RRP excl. (EUR) | RRP incl. (19.0%) |
|---------------|---------------------------------------------------------------------------------------------------------------------------|--------------------|----------------------|
| 000-00128-001 |  4-pin Power Cable for modules and MFDs. | 40.00 | 47.60 |



Fastnet

Main Products

| Part Number | Description | RRP excl. (EUR) | RRP incl. (19.0%) |
|-------------|------------------------------------------------------------------------------------------------------------------------|--------------------|----------------------|
| 239-00-099 |  Missing Image FastNet Terminator Kit | 14.00 | 16.66 |
| 135-0A-170 | Fastnet Kabel, 2m | 18.00 | 21.42 |





Misc

Main Products











| Part Number | Description | RRP excl. (EUR) | RRP incl. (19.0%) |
|-------------|--------------------------------------------------------------------------------------------------------------------------------------------------|--------------------|----------------------|
| 135-0A-097 |  MastBasis Prozessor Kabel (Wind) 9m | 39.00 | 46.41 |
| 135-0B-096 |  Stromkabel 15m - 0.5mm2, 2-adrig (auch Autopilot Relais Kabel) | 48.00 | 57.12 |
| 288-00-001 |  Anschlußdose - 7 Anschlüsse | 42.00 | 49.98 |







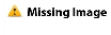

Naviop Kits

Main Products

| Part Number | Description | RRP excl. (EUR) | RRP incl. (19.0%) |
|---------------|----------------------------------------------------------------------------------------------------------------------------------------------------------------------------------------------------------------------------------------------------------------------------------------------------------------------------------------|-----------------|-------------------|
| 000-14666-001 |  Naviop LOOP S Digital Switching System Kit - Simple, yet powerful control and monitoring features through an integrated sidebar on an MFD showing dedicated functions. 8 fused relay controlled channels + 8 fused channels. | 1089.74 | 1296.79 |
| 000-14665-001 |  Naviop LOOP S+ Digital Switching System Kit - Simple, yet powerful control and monitoring features through an integrated sidebar on an MFD showing dedicated functions. 16 fused relay controlled channels + 16 fused channels. | 1882.84 | 2240.58 |
| 000-14664-001 |  Naviop LOOP M+ Digital Switching System Kit - A customized monitoring and control system sporting dedicated pages with a clear view of power board status, down to the single fuse or relay. 8 fused relay controlled channels + 8 fused channels. | 1687.14 | 2007.70 |
| 000-14663-001 |  Naviop LOOP M+ Digital Switching System Kit - A customized monitoring and control system sporting dedicated pages with a clear view of power board status, down to the single fuse or relay. 16 fused relay controlled channels + 16 fused channels. | 2675.94 | 3184.37 |

















Accessories









| Part Number | Description | RRP excl. (EUR) | RRP incl. (19.0%) |
|-----------------|--------------------------------------------------------------------------------------------------------------------------------------------------------------------------------|-----------------|-------------------|
| 000-15212-001 |  Naviop OP-BOX - LOOP M / M+ - Processing and protocols Unit with PLC programming capability. | 1029.00 | 1224.51 |
| BERMINI-USAA-1M |  Naviop OP-BOX USB Cable | 64.35 | 76.58 |
| 31M-316-0 |  Naviop EGON+ 12V DC 16 Channels - 8 channels Fuse+Relay, 8 channels Fuse only | 870.00 | 1035.30 |
| 31M-335-0 |  Naviop EGON+ 24V DC 16 Channels - 8 channels Fuse+Relay, 8 channels Fuse only | 870.00 | 1035.30 |
| 31M-336-0 |  Naviop EGON+ Power 12V DC - 8 channels Fuse+Relay | 870.00 | 1035.30 |
| 31M-337-0 |  Naviop EGON+ Power - 24V DC 16 Channels - 8 channels Fuse+Relay, 8 channels Fuse only | 870.00 | 1035.30 |
| 000-14844-001 |  Naviop EGON+ 12VDC Replacement Relay | 24.70 | 29.39 |
| C-EGON-01 |  Naviop EGON Power and CAN Cable - CAN ID 2 | 78.00 | 92.82 |
| C-EGON-02 |  Naviop EGON Power and CAN Cable - CAN ID 2 | 78.00 | 92.82 |
| C-EGON-03 |  Naviop EGON Power and CAN Cable - CAN ID 3 | 78.00 | 92.82 |
| C-EGON-04 |  Naviop EGON Power and CAN Cable - CAN ID 4 | 78.00 | 92.82 |

| Part Number | Description | RRP excl. (EUR) | RRP incl. (19.0%) |
|---------------|-----------------------------------------------------------------------------------------------------------------------------------------------------------------------------------------------------------------------------------------------------------------------------------------------------------------------------------------------------------------------------------------------------------------------------------------------------------------------|-----------------|-------------------|
| 000-14901-001 |  <p>Naviop EGON Plug Set- Includes 1x Blue connector, 1x Green connector, 1x Grey connector, 1x Black Connector, 24x EGON Power Contacts, 24x Cable Seals.</p> | 36.05 | 42.90 |
| C-28576 |  <p>Naviop CAN Drop Cable NA30</p> | 59.00 | 70.21 |
| C-28574 |  <p>Naviop CAN Drop Cable for NOVA+ - 1.2m</p> | 56.00 | 66.64 |
| C-34686 |  <p>Axial DB9 Male Cable for RS323/485 - 2m</p> | 30.50 | 36.30 |
| C-DAU-CABLE |  <p>Naviop Wiring Harness for DAU Units - 2m</p> | 105.00 | 124.95 |
| DAU-B-128 |  <p>Naviop DAU Bridge - CAN ID 128</p> | 1050.00 | 1249.50 |
| DAU-E-136 |  <p>Naviop DAU Easy - CAN ID 136</p> | 1050.00 | 1249.50 |
| DAU-E-137 |  <p>Naviop DAU Easy - CAN ID 137</p> | 1050.00 | 1249.50 |
| NA05-0003 |  <p>Naviop SE NOVA+ Light Board - NOVA+ is a solid state lighting control board designed specifically for use in marine environments, and enables dimmable lighting control of up to 8 separate circuits, each of them being protected by a pull-out fuse. Naviop-CAN connection to the monitoring and control system is available. Only for Naviop LOOP-P Systems.</p> | 930.00 | 1106.70 |
| NA05-0003-H |  <p>Naviop SE NOVA+ Light Board w/ Harness - NOVA+ is a solid state lighting control board designed specifically for use in marine environments, and enables dimmable lighting control of up to 8 separate circuits, each of them being protected by a pull-out fuse. Naviop-CAN connection to the monitoring and control system is available. Only for Naviop LOOP-P Systems.</p> | 950.00 | 1130.50 |

Naviop Parts

















Main Products



| Part Number | Description | RRP excl. (EUR) | RRP incl. (19.0%) |
|-----------------|--------------------------------------------------------------------------------------------------------------------------------------------------------------------------------------------------------------------------------------------|-----------------|-------------------|
| 000-15756-001 |  Naviop OP-BOX Programmable 1GHz | 1275.00 | 1517.25 |
| 000-15897-001 |  OP-BOX 1Ghz, Programmable, with Power cable | 989.00 | 1176.91 |
| 000-15212-001 |  Naviop OP-BOX - LOOP M / M+ - Processing and protocols Unit with PLC programming capability. | 1029.00 | 1224.51 |
| BERMINI-USAA-1M |  Naviop OP-BOX USB Cable | 64.35 | 76.58 |
| 000-13959-001 |  NAIS500/400 & Naviop OP-BOX Power & Serial Cable | 59.00 | 70.21 |
| 000-14991-001 |  Naviop AT30 Protocol Converter - N2K To Naviop CAN Gateway for bridging the vessels NMEA2000 network to the Naviop Digital Switching system. | 279.00 | 332.01 |
| 31M-316-0 |  Naviop EGON+ 12V DC 16 Channels - 8 channels Fuse+Relay, 8 channels Fuse only | 870.00 | 1035.30 |
| 31M-335-0 |  Naviop EGON+ 24V DC 16 Channels - 8 channels Fuse+Relay, 8 channels Fuse only | 870.00 | 1035.30 |
| 31M-336-0 |  Naviop EGON+ Power 12V DC - 8 channels Fuse+Relay | 870.00 | 1035.30 |
| 31M-337-0 |  Naviop EGON+ Power - 24V DC 16 Channels - 8 channels Fuse+Relay, 8 channels Fuse only | 870.00 | 1035.30 |
| 000-14844-001 |  Naviop EGON+ 12VDC Replacement Relay | 24.70 | 29.39 |
| C-EGON-01 |  Naviop EGON Power and CAN Cable - CAN ID 2 | 78.00 | 92.82 |
| C-EGON-02 |  Naviop EGON Power and CAN Cable - CAN ID 2 | 78.00 | 92.82 |
| C-EGON-03 |  Naviop EGON Power and CAN Cable - CAN ID 3 | 78.00 | 92.82 |
| C-EGON-04 |  Naviop EGON Power and CAN Cable - CAN ID 4 | 78.00 | 92.82 |
| 000-14901-001 |  Naviop EGON Plug Set- Includes 1x Blue connector, 1x Green connector, 1x Grey connector, 1x Black Connector, 24x EGON Power Contacts, 24x Cable Seals. | 36.05 | 42.90 |

| Part Number | Description | RRP excl. (EUR) | RRP incl. (19.0%) |
|-------------|----------------------------------------------------------------------------------------------------------------------------------------------------------------------------------------------------------------------------------------------------------------------------------------------------------------------------------------------------------------------------------------------------------------------------------------------------------------|-----------------|-------------------|
| C-28576 |  Naviop CAN Drop Cable NA30 | 59.00 | 70.21 |
| C-28574 |  Naviop CAN Drop Cable for NOVA+ - 1.2m | 56.00 | 66.64 |
| C-34686 |  Axial DB9 Male Cable for RS323/485 - 2m | 30.50 | 36.30 |
| C-DAU-CABLE |  Naviop Wiring Harness for DAU Units - 2m | 105.00 | 124.95 |
| DAU-B-128 |  Naviop DAU Bridge - CAN ID 128 | 1050.00 | 1249.50 |
| DAU-E-136 |  Naviop DAU Easy - CAN ID 136 | 1050.00 | 1249.50 |
| DAU-E-137 |  Naviop DAU Easy - CAN ID 137 | 1050.00 | 1249.50 |
| NA05-0003 |  Naviop SE NOVA+ Light Board - NOVA+ is a solid state lighting control board designed specifically for use in marine environments, and enables dimmable lighting control of up to 8 separate circuits, each of them being protected by a pull-out fuse. Naviop-CAN connection to the monitoring and control system is available. Only for Naviop LOOP-P Systems. | 930.00 | 1106.70 |
| NA05-0003-H |  Naviop SE NOVA+ Light Board w/ Harness - NOVA+ is a solid state lighting control board designed specifically for use in marine environments, and enables dimmable lighting control of up to 8 separate circuits, each of them being protected by a pull-out fuse. Naviop-CAN connection to the monitoring and control system is available. Only for Naviop LOOP-P Systems. | 950.00 | 1130.50 |

REVEAL™



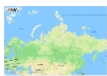











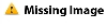

Main Products



| Part Number | Description | RRP excl. (EUR) | RRP incl. (19.0%) |
|--------------------------------------------------------------------------------------------------|---------------------------------------------------------------|-----------------|-------------------|
| M-AF-Y209-MS  | REVEAL: M-AF-Y209-MS South & East Africa | 199.00 | 236.81 |
| M-AF-Y210-MS  | REVEAL: M-AF-Y210-MS West Africa | 199.00 | 236.81 |
| M-EM-Y076-MS  | REVEAL: M-EM-Y076-MS South-West European Coasts | 199.00 | 236.81 |
| M-EM-Y111-MS  | REVEAL: M-EM-Y111-MS East Mediterranean, Caspian Seas | 199.00 | 236.81 |
| M-EN-Y070-MS  | REVEAL: M-EN-Y070-MS Central Europe Inland | 199.00 | 236.81 |
| M-EN-Y299-MS  | C-MAP REVEAL - M-EN-Y299-MS - Baltic Sea | 199.00 | 236.81 |
| M-EN-Y300-MS  | C-MAP REVEAL - M-EN-Y300-MS - North Sea & Denmark | 199.00 | 236.81 |
| M-EN-Y326-MS  | C-MAP REVEAL - M-EN-Y326-MS - Finland Lakes | 199.00 | 236.81 |
| M-EN-Y580-MS  | C-MAP REVEAL - M-EN-Y580-MS - Scandinavia Inland | 199.00 | 236.81 |
| M-EW-Y065-MS  | REVEAL: M-EW-Y065-MS France Coastal & Inland | 199.00 | 236.81 |
| M-EW-Y226-MS  | REVEAL: M-EW-Y226-MS United Kingdom | 199.00 | 236.81 |
| M-EW-Y227-MS  | REVEAL: M-EW-Y227-MS North-West European Coasts | 199.00 | 236.81 |
| M-EW-Y228-MS  | REVEAL: M-EW-Y228-MS West European Coasts | 199.00 | 236.81 |
| M-ME-Y204-MS  | REVEAL: M-ME-Y204-MS Red Sea to The Gulf & Seychelles Islands | 199.00 | 236.81 |
| M-RS-Y013-MS  | REVEAL: M-RS-Y013-MS Kamchatka Peninsula & Kuril Islands | 199.00 | 236.81 |
| M-RS-Y202-MS  | REVEAL: M-RS-Y202-MS Russian Federation – North West | 199.00 | 236.81 |
| M-RS-Y203-MS  | REVEAL: M-RS-Y203-MS Russian Federation – North Central | 199.00 | 236.81 |



| Part Number | Description | RRP excl. (EUR) | RRP incl. (19.0%) | |
|--------------|-----------------------------------------------------------------------------------|------------------------------------------------------|----------------------|--------|
| M-RS-Y204-MS |  | REVEAL: M-RS-Y204-MS Russian Federation – North East | 199.00 | 236.81 |
| M-RS-Y207-MS |  | REVEAL: M-RS-Y207-MS Hokkaido and Sakhalin Islands | 199.00 | 236.81 |

DISCOVER™

Main Products













| Part Number | Description | RRP excl. (EUR) | RRP incl. (19.0%) |
|--------------|----------------------------------------------------------------------------------------------------------------------------------------|--------------------|----------------------|
| M-AF-Y214-MS |  DISCOVER: M-AF-Y214-MS Cape Verde & Guinea Bissau | 129.00 | 153.51 |
| M-AF-Y200-MS |  DISCOVER: M-AF-Y200-MS Cameroon to South Africa | 129.00 | 153.51 |
| M-AF-Y201-MS |  DISCOVER: M-AF-Y201-MS South Africa to Mozambique | 129.00 | 153.51 |
| M-AF-Y220-MS |  DISCOVER: M-AF-Y220-MS Pemba to Mogadishu | 129.00 | 153.51 |
| M-EM-Y040-MS |  DISCOVER: M-EM-Y040-MS Italian Lakes & Po River | 129.00 | 153.51 |
| M-EM-Y200-MS |  DISCOVER: M-EM-Y200-MS West Mediterranean | 129.00 | 153.51 |
| M-EM-Y201-MS |  DISCOVER: M-EM-Y201-MS Central Mediterranean | 129.00 | 153.51 |
| M-EM-Y202-MS |  DISCOVER: M-EM-Y202-MS Mediterranean South Central | 129.00 | 153.51 |
| M-EM-Y203-MS |  DISCOVER: M-EM-Y203-MS Adriatic & Ionian Seas | 129.00 | 153.51 |
| M-EM-Y204-MS |  DISCOVER: M-EM-Y204-MS Aegean Sea & Sea of Marmara | 129.00 | 153.51 |
| M-EM-Y205-MS |  DISCOVER: M-EM-Y205-MS Black Sea & Sea of Azov | 129.00 | 153.51 |
| M-EM-Y206-MS |  DISCOVER: M-EM-Y206-MS Mediterranean South East | 129.00 | 153.51 |
| M-EN-Y200-MS |  C-MAP DISCOVER: M-EN-Y200-MS Bodø - Kirkenes | 129.00 | 153.51 |
| M-EN-Y201-MS |  DISCOVER: M-EN-Y201-MS Kristiansund - Finnsnes | 129.00 | 153.51 |
| M-EN-Y202-MS |  DISCOVER: M-EN-Y202-MS Bergen to Brandsfjorden | 129.00 | 153.51 |
| M-EN-Y203-MS |  DISCOVER: M-EN-Y203-MS Farsund to Måløy | 129.00 | 153.51 |
| M-EN-Y204-MS |  DISCOVER: M-EN-Y204-MS Fiskebäckskil to Lyndgal | 129.00 | 153.51 |











| Part Number | Description | RRP excl. (EUR) | RRP incl. (19.0%) |
|--------------|-------------------------------------------------------------------------------------------------------------------------------------------------------|-----------------|-------------------|
| M-EN-Y205-MS |  DISCOVER: M-EN-Y205-MS Karlskrona to Emden | 129.00 | 153.51 |
| M-EN-Y206-MS |  DISCOVER: M-EN-Y206-MS Torekov to Larvik | 129.00 | 153.51 |
| M-EN-Y207-MS |  DISCOVER: M-EN-Y207-MS Malmö to Valdemarsvik | 129.00 | 153.51 |
| M-EN-Y208-MS |  DISCOVER: M-EN-Y208-MS Västervik to Valdemarsvik | 129.00 | 153.51 |
| M-EN-Y209-MS |  DISCOVER: M-EN-Y209-MS Gulf of Bothnia | 129.00 | 153.51 |
| M-EN-Y210-MS |  DISCOVER: M-EN-Y210-MS Scandinavia Inland Waters | 129.00 | 153.51 |
| M-EN-Y211-MS |  DISCOVER: M-EN-Y211-MS Finland Lakes | 129.00 | 153.51 |
| M-EN-Y212-MS |  DISCOVER: M-EN-Y212-MS Gulf of Finland & Åland Islands Archipelago | 129.00 | 153.51 |
| M-EN-Y213-MS |  DISCOVER: M-EN-Y213-MS Latvia, Lithuania & Russia | 129.00 | 153.51 |
| M-EN-Y214-MS |  DISCOVER: M-EN-Y214-MS Polish Coast & Inland | 129.00 | 153.51 |
| M-EN-Y215-MS |  DISCOVER: M-EN-Y215-MS Germany & Netherland Inland | 129.00 | 153.51 |
| M-EN-Y216-MS |  DISCOVER: M-EN-Y216-MS Benelux Inland & Coastal | 129.00 | 153.51 |
| M-EN-Y217-MS |  DISCOVER: M-EN-Y217-MS Central Europe Inland | 129.00 | 153.51 |
| M-EN-Y218-MS |  DISCOVER: M-EN-Y218-MS Iceland, Faroe, Shetland & Orkney Islands | 129.00 | 153.51 |
| M-EN-Y630-MS |  DISCOVER: M-EN-Y630-MS Pechenga to Lumbovskiy Gulf | 129.00 | 153.51 |
| M-EW-Y206-MS |  DISCOVER: M-EW-Y206-MS French Inland Waters | 129.00 | 153.51 |
| M-EW-Y207-MS |  DISCOVER: M-EW-Y207-MS Bay of Biscay | 129.00 | 153.51 |
| M-EW-Y208-MS |  DISCOVER: M-EW-Y208-MS Portugal & Galicia | 129.00 | 153.51 |

| Part Number | Description | RRP excl. (EUR) | RRP incl. (19.0%) |
|--------------|--------------------------------------------------------------------------------------------------------------------------------------|-----------------|-------------------|
| M-EW-Y209-MS |  DISCOVER: M-EW-Y209-MS Canary Island to Gibraltar | 129.00 | 153.51 |
| M-ME-Y200-MS |  DISCOVER: M-ME-Y200-MS Red Sea | 129.00 | 153.51 |
| M-ME-Y201-MS |  DISCOVER: M-ME-Y201-MS Persian Gulf to Oman | 129.00 | 153.51 |
| M-RS-Y009-MS |  DISCOVER: M-RS-Y009-MS Kyongsong Man to Plastun | 129.00 | 153.51 |
| M-RS-Y221-MS |  DISCOVER: M-RS-Y221-MS White Sea | 129.00 | 153.51 |
| M-EW-Y060-MS |  DISCOVER: M-EW-Y060-MS Central & West Europe | 185.00 | 220.15 |
| M-RS-Y240-MS |  DISCOVER: M-RS-Y240-MS Tauyskaya Bay | 83.00 | 98.77 |
| M-AF-Y003-MS |  DISCOVER: M-AF-Y003-MS Antarctica | 185.00 | 220.15 |
| M-AF-Y050-MS |  DISCOVER: M-AF-Y050-MS Africa & Arabian Sea | 185.00 | 220.15 |
| M-EM-Y045-MS |  DISCOVER: M-EM-Y045-MS Southern Europe | 185.00 | 220.15 |
| M-EN-Y040-MS |  DISCOVER: M-EN-Y040-MS Greenland | 185.00 | 220.15 |
| M-EN-Y050-MS |  DISCOVER: M-EN-Y050-MS Northern & Central Europe | 185.00 | 220.15 |
| M-EN-Y055-MS |  DISCOVER: M-EN-Y055-MS Baltic Sea | 185.00 | 220.15 |
| M-EW-Y200-MS |  DISCOVER: M-EW-Y200-MS United Kingdom & Ireland | 150.86 | 179.53 |

DISCOVER™ X



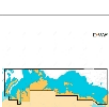









Main Products



| Part Number | Description | RRP excl. (EUR) | RRP incl. (19.0%) |
|-----------------------------------------------------------------------------------------------------|----------------------------------------------------------------|-----------------|-------------------|
| M-AF-T-050-D-MS  | AF-T-050-D-MS - DISCOVER X Africa, Arabic Sea | 187.70 | 223.37 |
| M-AF-T-209-D-MS  | AF-T-209-D-MS - DISCOVER X South and East Africa | 130.33 | 155.09 |
| M-AF-T-210-D-MS  | AF-T-210-D-MS - DISCOVER X West Africa | 130.33 | 155.09 |
| M-EM-T-045-D-MS  | EM-T-045-D-MS - DISCOVER X Southern Europe | 187.70 | 223.37 |
| M-EM-T-076-D-MS  | EM-T-076-D-MS - DISCOVER X West Mediterranean | 130.33 | 155.09 |
| M-EM-T-111-D-MS  | EM-T-111-D-MS - DISCOVER X East Mediterranean | 130.33 | 155.09 |
| M-EM-T-112-D-MS  | EM-T-112-D-MS - DISCOVER X Black and Caspian Seas | 130.33 | 155.09 |
| M-EN-T-050-D-MS  | EN-T-050-D-MS - DISCOVER X Northern, Central Europe | 187.70 | 223.37 |
| M-EN-T-055-D-MS  | EN-T-055-D-MS - DISCOVER X Sweden, Finland Baltic Sea | 187.70 | 223.37 |
| M-EN-T-200-D-MS  | EN-T-200-D-MS - DISCOVER X Skagerrak, Kattegatt and Baltic Sea | 130.33 | 155.09 |
| M-EN-T-218-D-MS  | EN-T-218-D-MS - DISCOVER X Greenland and Iceland | 130.33 | 155.09 |
| M-EN-T-040-D-MS  | EN-T-040-D-MS - DISCOVER X Greenland | 187.70 | 223.37 |
| M-EN-T-300-D-MS  | EN-T-300-D-MS - DISCOVER X North Sea | 130.33 | 155.09 |

| Part Number | Description | RRP excl. (EUR) | RRP incl. (19.0%) |
|-----------------------------------------------------------------------------------------------------|------------------------------------------------------------------|-----------------|-------------------|
| M-EN-T-326-D-MS  | EN-T-326-D-MS - DISCOVER X Finland Inland and Baltic Sea | 130.33 | 155.09 |
| M-EN-T-580-D-MS  | EN-T-580-D-MS - DISCOVER X Scandinavia Inland | 130.33 | 155.09 |
| M-EW-T-060-D-MS  | EW-T-060-D-MS - DISCOVER X Central-West Europe | 187.70 | 223.37 |
| M-EW-T-226-D-MS  | EW-T-226-D-MS - DISCOVER X United Kingdom | 130.33 | 155.09 |
| M-EW-T-227-D-MS  | EW-T-227-D-MS - DISCOVER X North-West Europe | 130.33 | 155.09 |
| M-EW-T-228-D-MS  | EW-T-228-D-MS - DISCOVER X West European Coasts | 130.33 | 155.09 |
| M-RS-T-013-D-MS  | RS-T-013-D-MS - DISCOVER X Kamchatka Peninsula and Kuril Islands | 130.33 | 155.09 |
| M-RS-T-202-D-MS  | RS-T-202-D-MS - DISCOVER X Russian Federation North West | 130.33 | 155.09 |
| M-RS-T-204-D-MS  | RS-T-204-D-MS - DISCOVER X Russian Federation North East | 130.33 | 155.09 |
| M-RS-T-210-D-MS  | RS-T-210-D-MS - DISCOVER X West Russia Inland | 130.33 | 155.09 |
| M-RS-T-211-D-MS  | RS-T-211-D-MS - DISCOVER X East Russia Inland | 130.33 | 155.09 |

REVEAL™X COASTAL













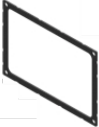

Main Products

















| Part Number | Description | RRP excl. (EUR) | RRP incl. (19.0%) |
|-----------------------------------------------------------------------------------------------------|-------------------------------------------------------------|-----------------|-------------------|
| M-AF-T-209-R-MS  | AF-T-209-R-MS - REVEAL X South and East Africa | 204.10 | 242.88 |
| M-AF-T-210-R-MS  | AF-T-210-R-MS - REVEAL X West Africa | 204.10 | 242.88 |
| M-EM-T-076-R-MS  | EM-T-076-R-MS - REVEAL X West Mediterranean | 204.10 | 242.88 |
| M-EM-T-111-R-MS  | EM-T-111-R-MS - REVEAL X East Mediterranean | 204.10 | 242.88 |
| M-EM-T-112-R-MS  | EM-T-112-R-MS - REVEAL X Black and Caspian Seas | 204.10 | 242.88 |
| M-EN-T-200-R-MS  | EN-T-200-R-MS - REVEAL X Skagerak, Kattegatt and Baltic Sea | 204.10 | 242.88 |
| M-EN-T-218-R-MS  | EN-T-218-R-MS - REVEAL X Greenland and Iceland | 204.10 | 242.88 |
| M-EN-T-300-R-MS  | EN-T-300-R-MS - REVEAL X North Sea | 204.10 | 242.88 |
| M-EN-T-326-R-MS  | EN-T-326-R-MS - REVEAL X Finland Inland and Baltic Sea | 204.10 | 242.88 |
| M-EN-T-580-R-MS  | EN-T-580-R-MS - REVEAL X Scandinavia Inland | 204.10 | 242.88 |
| M-EW-T-226-R-MS  | EW-T-226-R-MS - REVEAL X United Kingdom | 204.10 | 242.88 |
| M-EW-T-227-R-MS  | EW-T-227-R-MS - REVEAL X North-West Europe | 204.10 | 242.88 |
| M-EW-T-228-R-MS  | EW-T-228-R-MS - REVEAL X West European Coasts | 204.10 | 242.88 |

















| Part Number | Description | RRP excl. (EUR) | RRP incl. (19.0%) | |
|-----------------|-----------------------------------------------------------------------------------|----------------------------------------------------------------|----------------------|--------|
| M-ME-T-204-R-MS |  | ME-T-204-R-MS - REVEAL X Red Sea, The Gulf and Seychelles Is. | 204.10 | 242.88 |
| M-RS-T-013-R-MS |  | RS-T-013-R-MS - REVEAL X Kamchatka Peninsula and Kuril Islands | 204.10 | 242.88 |









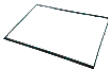

Navigation

Main Products

| Part Number | Description | RRP excl. (EUR) | RRP incl. (19.0%) |
|---------------|-----------------------------------------------------------------------------------------------------------------------------------------------------------------------------------------------------------------------------------------------------------------------------------------------------------------------|-----------------|-------------------|
| 000-13172-001 |  Vulcan-5 Suncover | 14.99 | 17.84 |
| 000-14228-001 |  Vulcan 7R Suncover | 20.00 | 23.80 |
| 000-13701-001 |  Vulcan 9 Suncover | 27.00 | 32.13 |
| 000-14152-001 |  Vulcan 12 Suncover | 30.89 | 36.76 |
| 000-12374-001 |  Flush mount O'ring type seal for use with the Flush mount kit for GO7 & Vulcan 7 displays. | 22.00 | 26.18 |
| 000-12373-001 |  Replacement panel / dashboard gasket for GO7 & Vulcan 7 displays | 11.00 | 13.09 |
| 000-12372-001 |  Mounting bracket for Simrad NSX 3007, GO7 XSR, I3007, P3007, and B&G Vulcan 7R, | 29.00 | 34.51 |
| 000-12366-001 |  FLUSH MOUNT KIT,GO7 & VULCAN 7 Note: If flush mounting the Go7 or Vulcan 7 you may need the specific sun cover for the flush mount installation method. For GO7 please order 000-12368-001 or for Vulcan order 000-12370-001). | 30.59 | 36.40 |
| 000-15819-001 |  B&G Zeus S 7 Suncover | 29.99 | 35.69 |
| 000-15820-001 |  B&G Zeus S 9 Suncover | 29.99 | 35.69 |
| 000-15821-001 |  B&G Zeus S 12 Suncover | 34.99 | 41.64 |
| 000-13744-001 |  B&G Zeus³ 7" Sun cover | 26.00 | 30.94 |
| 000-13745-001 |  B&G Zeus³S 9" Sun cover | 29.00 | 34.51 |
| 000-13746-001 |  B&G Zeus³S 12" Sun cover | 32.00 | 38.08 |
| 000-13747-001 |  B&G Zeus³S 16" Sun cover | 35.00 | 41.65 |
| 000-15635-001 |  B&G Magnetic Suncover for 16" Monitor | 95.00 | 113.05 |

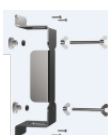













| Part Number | Description | RRP excl. (EUR) | RRP incl. (19.0%) |
|---------------|-------------------------------------------------------------------------------------------------------------------------------------------------------------------------------------------------------|-----------------|-------------------|
| 000-14357-001 |  B&G Suncover for 16" Monitor | 92.70 | 110.31 |
| 000-15636-001 |  B&G Magnetic Suncover for 19" Monitor | 125.00 | 148.75 |
| 000-14358-001 |  B&G Suncover for 19" Monitor | 108.15 | 128.70 |
| 000-15637-001 |  B&G Magnetic Suncover for 24" Monitor | 190.00 | 226.10 |
| 000-14359-001 |  B&G Suncover for 24" Monitor | 133.90 | 159.34 |
| 000-11248-001 |  HDMI monitor video cable 3 m (9.8 ft) | 23.99 | 28.55 |
| 000-11249-001 |  HDMI monitor video cable 10 m (33 ft) | 56.09 | 66.75 |
| 000-00129-001 |  Video/Data Cable - Provides 2x Analog Composite Video Inputs (RCA Female) and a NMEA 0183 Interface. | 28.00 | 33.32 |
| 000-12742-001 |  HDMI Cable with vibration resistant and waterproof connector on one end to connect to Navico MFDs with HDMI port. | 54.00 | 64.26 |
| 000-12741-001 |  HDMI Cable with vibration resistant and waterproof connector on one end to connect to Navico MFDs with HDMI port. | 87.00 | 103.53 |
| 000-13748-001 |  NSSevo3 & ZEUS ³ Chart Card Door | 14.00 | 16.66 |
| 000-13749-001 |  NSSevo3 & ZEUS ³ 7" Edge Bezels | 16.00 | 19.04 |
| 000-13750-001 |  NSSevo3/3S & ZEUS ^{3/3S} 9" Edge Bezels | 18.00 | 21.42 |
| 000-13751-001 |  NSSevo3/3S & ZEUS ^{3/3S} 12" Edge Bezels | 20.00 | 23.80 |
| 000-13752-001 |  NSSevo3/3S & ZEUS ^{3/3S} 16" Edge Bezels | 25.00 | 29.75 |
| 000-13753-001 |  NSSevo3 & ZEUS ³ 7" Dash Mount Kit | 20.00 | 23.80 |
| 000-13754-001 |  NSSevo3/3S & ZEUS ^{3/3S} 9" Dash Mount Kit | 23.00 | 27.37 |







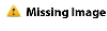







| Part Number | Description | RRP excl. (EUR) | RRP incl. (19.0%) |
|---------------|------------------------------------------------------------------------------------------------------------------------------------------------------------------------------------------------------------------------------------------------------------------------------|-----------------|-------------------|
| 000-13755-001 |  NSSevo3/3S & ZEUS ³ /3S 12" Dash Mount Kit | 27.00 | 32.13 |
| 000-13756-001 |  NSSevo3/3S & ZEUS ³ /3S 16" Dash Mount Kit | 36.00 | 42.84 |
| 000-13758-001 |  NSSevo3/3S & ZEUS ³ /3S 9" Mounting Bracket (Plastic) | 36.00 | 42.84 |
| 000-13759-001 |  NSSevo3/3S & ZEUS ³ /3S 12" Mounting Bracket | 66.00 | 78.54 |
| 000-13760-001 |  NSS16evo3/3S & ZEUS ³ /3S 16" Mounting Bracket (Metal) | 69.00 | 82.11 |
| 000-14317-001 |  Replacement Rotary knob for Simrad NSS evo3 & Zeus ³ MFDs | 22.00 | 26.18 |
| 000-13547-001 |  Extra heavy duty Gimbal bracket for desk-mounting the M5000 IMO Monitors, Simrad MO-Series Touch Monitors, B&G ZM-Series Monitors as well as NSO evo3S MFD and Zeus3S Glass Helm Displays. | 322.00 | 383.18 |
| 000-11618-001 |  MO, NSO evo3 16/19/24,Rear mount bracket kit. Includes: dash seal for 16,19,24" and Bracket kit | 63.00 | 74.97 |
| 000-14488-001 |  Missing Image Spacer required if using the Heavy Duty Gimbal bracket kit (000-13547-001) to mount an NSO16 evo3 or ZEUS3-16 display.(not required for 19 and 24 " displays) | 51.49 | 61.27 |
| 000-13171-001 |  GO5 & Vulcan-5 Power & N2K Cable | 38.00 | 45.22 |
| 000-10027-001 |  Quick Release Bracket - GO5 / Vulcan5 / P2005 / I3005 / Mark / Elite | 26.99 | 32.12 |
| 000-13170-001 |  Edge Bezel for P2005, I3005, GO5 & Vulcan-5 | 11.00 | 13.09 |
| 000-13169-001 |  Dash Mount kit for P2005, I3005, GO5 & Vulcan-5 | 14.00 | 16.66 |
| 000-14230-001 |  Edge Bezel for GO7 XSR, Vulcan 7R, I3007 & P3007 | 17.00 | 20.23 |
| 000-14229-001 |  Dash Mount Kit for GO7 XSR, Vulcan 7R, I3007 & P3007 | 22.00 | 26.18 |
| 000-13699-001 |  GO9 XSE & Vulcan 9 Dash Mount Kit | 22.00 | 26.18 |
| 000-13700-001 |  Replacement bezel for Simrad GO9 or B&G Vulcan9. | 18.00 | 21.42 |

| Part Number | Description | RRP excl. (EUR) | RRP incl. (19.0%) |
|--------------------|---------------------------------------------------------------------------------------------------------------------------------------------------------------------------------------------------------------------------------------------------|-----------------|-------------------|
| 000-13702-001 |  Gimbal mounting bracket for Simrad NSX 3009, GO9, NSS7 evo3,, and B&G Vulcan9, Zeus3 7 (Plastic) | 33.00 | 39.27 |
| 000-14247-001 |  GO12 & Vulcan 12 Edge Bezel | 22.00 | 26.18 |
| 000-14148-001 |  U-BRACKET 12" GO, VULCAN, NSX, ZEUS S | 33.00 | 39.27 |
| 000-11247-001 |  NSOevo2, NSOevo3S, Zeus2 and Zeus3S NMEA0183 and Touch Monitor Serial Cable. 2m (6.5 ft) | 21.00 | 24.99 |
| 000-13892-001 |  MI10 Dashmount microSD card reader: Provides a dual Chart Card reader for use with NSO and Zeus MFD / MPU systems. | 219.00 | 260.61 |
| 000-12743-001 |  OP50 / ZC2 Suncover | 14.00 | 16.66 |
| 000-12746-001 |  OP50 / ZC2 Dial Knob with grub screw | 41.19 | 49.02 |
| 000-12745-001 |  OP50 / ZC2 Flush Mounting Bracket Kit | 88.00 | 104.72 |
| 000-12744-001 |  OP50 / ZC2 Dash Mounting Kit | 14.00 | 16.66 |
| 000-13703-001 |  Auto-Stby Button - Metal. For a physical Auto/Stby button in systems with NAC-1 and NAC-2 Autopilot Computers. | 48.00 | 57.12 |
| 000-15475-001 | WM-4 SIRIUS SAT WEATHER ETHERNET EXT 5M | 52.00 | 61.88 |
| Accessories | | | |
| Part Number | Description | RRP excl. (EUR) | RRP incl. (19.0%) |
| 000-00129-001 |  Video/Data Cable - Provides 2x Analog Composite Video Inputs (RCA Female) and a NMEA 0183 Interface. | 28.00 | 33.32 |
| 000-14488-001 |  Spacer required if using the Heavy Duty Gimbal bracket kit (000-13547-001) to mount an NSO16 evo3 or ZEUS3-16 display.(not required for 19 and 24 " displays) | 51.49 | 61.27 |







Instrumente

Main Products

| Part Number | Description | RRP excl. (EUR) | RRP incl. (19.0%) |
|---------------|---------------------------------------------------------------------------------------------------------------------------------------------------------------------------------------------------------|-----------------|-------------------|
| 000-12892-001 | SUN COVER,H5000 DISPLAYS | 20.00 | 23.80 |
| 000-12893-001 | SUN COVER,H5000 PILOT KEYPAD | 18.00 | 21.42 |
| 000-15822-001 |  Corner bezel clips for NSX range of displays. Set of four corner clips | 24.99 | 29.74 |
| 000-13725-001 |  Suncover for Simrad OP12 and B&G Triton ² Pilot controllers | 14.00 | 16.66 |
| 000-15868-001 |  B&G Nemesis™ 9 Spare Suncover | 31.60 | 37.60 |
| 000-15869-001 |  B&G Nemesis™ 12 Spare Suncover | 34.50 | 41.06 |
| 000-15893-001 |  B&G Nemesis™ 9 Mast Bracket | 280.00 | 333.20 |
| 000-15894-001 |  B&G Nemesis™ 12 Mast Bracket | 325.00 | 386.75 |
| 000-14547-001 |  Power / Ethernet cable, 5 m (16.5 ft) for HALO dome radars and B&G Nemesis displays | 77.00 | 91.63 |
| 000-14548-001 |  Power / Ethernet cable, 10 m (33 ft) for HALO dome radars and B&G Nemesis displays | 119.00 | 141.61 |
| 000-14549-001 |  Power / Ethernet cable, 20 m (65.5 ft) for HALO dome radars and B&G Nemesis displays | 179.00 | 213.01 |
| 000-14550-001 |  Power / Ethernet cable, 30 m (98.5 ft) for HALO dome radars and B&G Nemesis displays | 239.00 | 284.41 |
| 000-15545-001 |  Gasket for H5000 Graphic/Race Displays 5-pack | 15.00 | 17.85 |
| 000-15740-001 |  Nemesis™ Power & Ethernet Hub Interconnect cable. 60cm (2 ft). One required per display to be connected to the Hub. | 69.00 | 82.11 |
| 000-15546-001 |  Gasket for 20/20 HV Display 5-pack | 17.00 | 20.23 |
| BGH320001 |  10/10HV Display Pack for H3000 and WTP3 systems. | 539.00 | 641.41 |
| BGH290001 |  20/20HV Display Pack for H3000 and WTP3 systems | 1210.00 | 1439.90 |



| Part Number | Description | RRP excl. (EUR) | RRP incl. (19.0%) |
|---------------|-----------------------------------------------------------------------------------------------------------------------------------------------------------------|-----------------|-------------------|
| BGH240001 |  30/30HV Display Pack for H3000 and WTP3 systems. | 2350.00 | 2796.50 |
| BGH280001 |  40/40HV Display Pack for H3000 and WTP3 systems | 3890.00 | 4629.10 |
| 000-15547-001 |  Gasket for 30/30 HV Display 5-pack | 48.00 | 57.12 |
| 000-15548-001 |  Gasket for 40/40 HV Display 5-pack | 86.00 | 102.34 |
| 000-13722-001 |  Suncover for B&G Triton² Display | 15.00 | 17.85 |
| 000-13950-001 |  IS42 & Triton2 Installation Kit - Includes edge bezel, screws and guide tool. | 14.00 | 16.66 |
| 000-13952-001 |  Triton2 Pilot & OP12 Installation Kit | 14.00 | 16.66 |
| 000-12614-001 | H5000 Displays - Edge Cover Set | 8.00 | 9.52 |
| 000-12615-001 |  H5000 Pilot Controller Edge Cover Set | 8.00 | 9.52 |
| 037-03195 |  FFD Elastomeric | 28.00 | 33.32 |
| 037-03607 |  20/20 Elastomeric | 15.00 | 17.85 |
| 239-30-068 |  Display Mounting Gasket (FFD, 20/20 mk.1 | 5.00 | 5.95 |
| 000-10568-001 |  Accessory plug assembly for DST800 | 24.00 | 28.56 |
| 000-11740-001 |  Airmar 110WX/ 120WX Cable 6 m (19.6 ft) (NMEA 2000 to Device cable) | 60.00 | 71.40 |
| 000-10388-001 | Ersatzteil Kit Paddelrad für DST800 | 35.00 | 41.65 |
| 000-10862-001 |  TRITON DISPLAY MAIN MOUNTING KIT | 28.00 | 33.32 |
| 000-12899-001 | USB PORT COVER,H5000 GRAPHIC DISPLAY | 10.00 | 11.90 |
| 000-12897-001 | GROMMET PACK,H5000 MODULES | 16.48 | 19.61 |
| 000-12896-001 | GROMMET PACK,H5000 CPU | 16.48 | 19.61 |
| 000-12895-001 | CONNECTOR PACK (Green),H5000 PILOT CPU | 65.00 | 77.35 |
| 000-12898-001 | CONN PACK,H5000 EXPANSION MODULES | 23.69 | 28.19 |
| 000-12894-001 | CONN PACK,H5000 CPU | 65.00 | 77.35 |

Accessories

| Part Number | Description | RRP excl. (EUR) | RRP incl. (19.0%) |
|-------------|---------------------------------------------------------------------------------------------------------------------|-----------------|-------------------|
| BGH301035 |  B&G SimNet Kabel 0.35m, gewinkelt | 36.00 | 42.84 |
| BGH220013 |  20/20 HV Mast Halter (3-fach) | 220.00 | 261.80 |
| BGH220014 |  20/20 HV Mast Halter (4-fach) | 310.00 | 368.90 |
| BGH220015 |  20/20 HV Mast Halter (5-fach) | 378.00 | 449.82 |
| BGH291017 |  20/20HV Rahmen (weiß) | 61.00 | 72.59 |
| BGH291018 |  20/20HV Rahmen (Rot) | 61.00 | 72.59 |
| BGH291019 |  20/20HV Rahmen (Grün) | 61.00 | 72.59 |

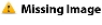
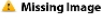
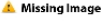
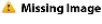
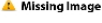
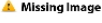
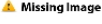















Spare Parts





| Part Number | Description | RRP excl. (EUR) | RRP incl. (19.0%) |
|-------------|--------------------------------------------------------------------------------------------------------------|-----------------|-------------------|
| BGH281011 |  40/40HV Rahmen (schwarz) | 66.00 | 78.54 |
| BGH284014 |  40/40HV Sun Cover | 37.00 | 44.03 |
| BGH241011 |  30/30HV Rahmen schwarz | 60.00 | 71.40 |
| BGH244014 |  30/30HV Sun Cover | 36.00 | 42.84 |
| BGH291001 |  20/20HV Display only | 1145.00 | 1362.55 |
| BGH291011 |  20/20HV Rahmen (schwarz) | 45.00 | 53.55 |
| BGH321011 |  10/10HV Bezel (schwarz) | 27.00 | 32.13 |

| Part Number | Description | RRP excl. (EUR) | RRP incl. (19.0%) |
|-------------|--------------------------------------------------------------------------------------------------------------------|-----------------|-------------------|
| BGH324014 |  10/10HV Sun Cover | 20.00 | 23.80 |
| BGH231021 |  H3000 Analog: Echolot ft/fathoms | 28.00 | 33.32 |
| BGH234017 |  H3000 analog Schutzkappen | 18.00 | 21.42 |

Sensoren

Main Products

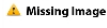







| Part Number | Description | RRP excl. (EUR) | RRP incl. (19.0%) |
|---------------|--------------------------------------------------------------------------------------------------------------------------------------------------------------------------------------------------------------------------------------------------|-----------------|-------------------|
| 000-15144-001 |  Wind vane assembly spare for WS300/700 series wind sensors. Inc. mounting nut. | 48.00 | 57.12 |
| 000-15615-001 | Replacement PCB for the WS320 wind sensor. | 298.00 | 354.62 |
| 000-15143-001 |  WS300/700 Support Moulding inc. O-Ring | 17.00 | 20.23 |
| 000-11675-001 |  ForwardScan™ Transducer Only. With 10m (33ft) Cable | 550.00 | 654.50 |
| 000-15142-001 |  Replacement wind angle bearing for the WS300/700 series wind sensors. | 83.00 | 98.77 |
| 000-15140-001 |  Wind Speed Cup spare for all B&G MHUs (508, 608, 213, VMHU, WS300, WS700) | 31.00 | 36.89 |
| 000-15141-001 |  Replacement battery for WS320 wireless wind sensor. | 22.00 | 26.18 |
| 000-13578-001 |  ForwardScan™ Long-Stem Housing Only | 207.99 | 247.51 |
| 000-15139-001 |  Replacement PCB for WS700/310 series wind sensors. | 298.00 | 354.62 |
| 213-10-038 |  Replacement wind speed bearing for all B&G MHUs (508, 608, 213, VMHU, WS300, WS700) | 92.00 | 109.48 |
| MHU-NUTS |  Replacement mounting nuts for wind vane and cups for all B&G MHUs (508, 608, 213, VMHU, WS300, WS700) | 20.00 | 23.80 |
| 000-14388-001 |  The WS320 Wireless Interface: Spare Wireless Interface for the WS320 Wind Sensor system. Receives wireless signals from the WS320 and converts to NMEA 2000. | 182.00 | 216.58 |
| 000-13715-001 |  608 Wind Sensor spare PCB assembly. Compatible with 608 and 508 Wind Sensors | 190.00 | 226.10 |
| 000-13714-001 |  Networked wind sensor for Triton2, Triton, IS42, IS40 and IS20 systems. Sensor only, does not include cable. | 430.00 | 511.70 |
| 275-00-031 |  XTL Fin - Bronze Bolzen, erweiterte Länge, Log und Echolot | 2650.00 | 3153.50 |
| 275-00-045 |  XTL Fin - VA Bolzen, Standart Länge, nur Log | 2450.00 | 2915.50 |
| 000-13579-001 | ForwardScan™ Long-Stem Fairing Block Only | 53.99 | 64.25 |
| SEN-RUD-LFB |  Ruderlagerückgeber, Linear Typ (kompatibel mit RAM-T1-xxx und RAM-T2-xxx) | 512.00 | 609.28 |
| BGH033004 |  V-Mast Head Unit Cable Loom assembly (for 810 mm (32")) | 130.00 | 154.70 |









| Part Number | Description | RRP excl. (EUR) | RRP incl. (19.0%) |
|---------------|------------------------------------------------------------------------------------------------------------------------------|-----------------|-------------------|
| SEN-RUD-LF2 |  Seebodengehäuse Blindstopfen (Log) [<2006] | 512.00 | 609.28 |
| 000-13716-001 |  Bracket Kit - Water Level or Antenna Mount | 6.18 | 7.35 |
| 000-10573-001 |  IS20 Windfahnen Masthalterung | 65.92 | 78.44 |
| 000-0127-54 |  Stromkabel BSM-1, LSS-2 | 48.00 | 57.12 |

Accessories

| Part Number | Description | RRP excl. (EUR) | RRP incl. (19.0%) |
|---------------|---------------------------------------------------------------------------------------------------------------------------------------------------------------------|-----------------|-------------------|
| 000-10757-001 |  Kabel 20 m (66 ft) NMEA2000 Wind-Masteinheit (Micro-C male - Simnet) | 96.00 | 114.24 |
| 000-10758-001 |  Kabel 35 m (66 ft) NMEA2000 Wind-Masteinheit (Micro-C male - Simnet) | 133.00 | 158.27 |
| 178-0B-001 |  24m Mast Kabel und Halter (für 213 Windmeßgeber, Standart Version) | 336.00 | 399.84 |
| 178-0D-001 |  36m Mast Kabel und Halter (für 213 Windmeßgeber, Standart Version) | 440.00 | 523.60 |
| 178-0X-001 |  36m extra leicht Mast Kabel und Halter (für 213 Windmeßgeber, Standart Version) | 570.00 | 678.30 |









Spare Parts

| Part Number | Description | RRP excl. (EUR) | RRP incl. (19.0%) |
|---------------|--------------------------------------------------------------------------------------------------------------------------------------------------------------------------------------------------|-----------------|-------------------|
| 000-12232-001 |  ForwardScan™ O-Ring (Color of supplied O-Ring may vary from shown) | 6.49 | 7.72 |
| 213-10-038 |  Replacement wind speed bearing for all B&G MHUs (508, 608, 213, VMHU, WS300, WS700) | 92.00 | 109.48 |
| MHU-NUTS |  Replacement mounting nuts for wind vane and cups for all B&G MHUs (508, 608, 213, VMHU, WS300, WS700) | 20.00 | 23.80 |
| 000-13715-001 |  608 Wind Sensor spare PCB assembly. Compatible with 608 and 508 Wind Sensors | 190.00 | 226.10 |
| 000-13714-001 |  Networked wind sensor for Triton2, Triton, IS42, IS40 and IS20 systems. Sensor only, does not include cable. | 430.00 | 511.70 |
| 000-10573-001 |  IS20 Windfahnen Masthalterung | 65.92 | 78.44 |
| 178-30-023 |  213 Kabel Mutter (Kabel an Halter) | 63.00 | 74.97 |
| 213-10-003 |  213 Windmeßgeber nur Gehäuse (Standart Version) | 480.00 | 571.20 |

| Part Number | Description | RRP excl. (EUR) | RRP incl. (19.0%) |
|--------------|-------------------------------------------------------------------------------------------------------------------------------------------------------------------|--------------------|----------------------|
| 213-10-004 |  Missing Image Windrichtung Lager (für 213 oder 496 Windmeßgeber) | 83.00 | 98.77 |
| 213-10-056 |  Missing Image Wind Fahne (für 213 oder 496 Windmeßgeber) | 42.00 | 49.98 |
| 213-10-101 |  Missing Image 213 Windmeßgeber Platine | 359.00 | 427.21 |
| MHU-MLDGS |  Missing Image 213/496 Aussengehäuse | 62.00 | 73.78 |
| SEN-DEPTH-A2 |  Missing Image Echolot-Sensor, aktiv NMEA0183 - 235 KHz - nur Sensor, ohne Kabel | 390.00 | 464.10 |
| SEN-DEPTH-H |  Missing Image H3000 Tiefensensor mit 15m Kabel | 160.00 | 190.40 |
| SEN-PLUG-DPT |  Missing Image Seebodengehäuse Blindstopfen (Echolot) | 49.00 | 58.31 |
| BGH063001 |  Missing Image Halcyon Gyro-Stabilised Kompassgeber Kabel | 218.00 | 259.42 |

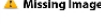
Radars



Main Products

| Part Number | Description | RRP excl. (EUR) | RRP incl. (19.0%) |
|---------------|--------------------------------------------------------------------------------------------------------------------------------------------------------------------------------------------------------------------------------------------------------------------------------------------------------------------------|-----------------|-------------------|
| 000-11465-001 |  HALO Antenna Only - 4ft | 1295.83 | 1542.04 |
| 000-11466-001 |  HALO Antenna Only - 6ft | 1829.17 | 2176.71 |
| 000-11464-001 |  HALO Antenna Only - 3ft | 745.83 | 887.54 |
| 000-10795-001 |  SC20 Mast mount kit for HALO 20/20+ and Broadband Dome Radars. | 389.00 | 462.91 |
| 000-10904-001 |  Radar-Verlängerungskabel 2 m für Broadband Radarantennen | 66.00 | 78.54 |
| 000-10905-001 |  Radar-Verlängerungskabel 5 m für Broadband Radarantennen | 77.00 | 91.63 |
| 000-14551-001 |  Enables re-use of the existing BR24/3G/4G cable onboard when upgrading to a HALO Dome radar. | 65.00 | 77.35 |
| 000-12514-001 |  HALO Pedestal, Spare mounting kit. Includes -4 x Bolt, HEX, M12x35, 316 s/s: 4 x Bolt, HEX, M12x50, 316 s/s: -4 x Washer, Flat, M12x36x3, 316 s/s: -4 x Washer, Spring, M12, 316 s/s: -8 x Washer, Isolating M12x38 Nylon | 66.00 | 78.54 |
| 000-12515-001 |  HALO Antenna - Spare Mounting Kit. M8 Dome Nuts, M8 Spring Washers, M8x16x1.2 Flat Washers. 316 SS, 4pcs each. | 41.00 | 48.79 |

Accessories











| Part Number | Description | RRP excl. (EUR) | RRP incl. (19.0%) |
|---------------|----------------------------------------------------------------------------------------------------------------------------------------------------------------------------------|-----------------|-------------------|
| 000-14551-001 |  Enables re-use of the existing BR24/3G/4G cable onboard when upgrading to a HALO Dome radar. | 65.00 | 77.35 |

Spare Parts

| Part Number | Description | RRP excl. (EUR) | RRP incl. (19.0%) |
|---------------|---------------------------------------------------------------------------------------------------------------------------------------------------------------------------------------------------------------------------------------------------------------------------------------------------------------------------|-----------------|-------------------|
| 000-12514-001 |  HALO Pedestal, Spare mounting kit. Includes -4 x Bolt, HEX, M12x35, 316 s/s: 4 x Bolt, HEX, M12x50, 316 s/s: -4 x Washer, Flat, M12x36x3, 316 s/s: -4 x Washer, Spring, M12, 316 s/s: -8 x Washer, Isolating M12x38 Nylon | 66.00 | 78.54 |
| 000-12515-001 |  HALO Antenna - Spare Mounting Kit. M8 Dome Nuts, M8 Spring Washers, M8x16x1.2 Flat Washers. 316 SS, 4pcs each. | 41.00 | 48.79 |

Autopilot/Steering

Main Products







| Part Number | Description | RRP excl. (EUR) | RRP incl. (19.0%) |
|---------------|-----------------------------------------------------------------------------------------------------------------------------------------------------------------|-----------------|-------------------|
| 000-14463-001 | NAC-2 Spare Drive Cable - 2m (6.5 ft) | 38.00 | 45.22 |
| 20997953 |  RPU80/100/150/160/200 Seal Kit. Works for all motor types and pump sizes. | 97.00 | 115.43 |
| 21118617 |  RPU80 Motor Brushes - Framco | 58.00 | 69.02 |
| 21118633 |  RPU160 Motor Brushes - Framco | 69.00 | 82.11 |
| 21118625 |  RPU Motor Brushes - Framco for RPU300 | 69.00 | 82.11 |
| 21118666 |  RPU Motor Brushes - Lemac for RPU80/160 | 81.00 | 96.39 |
| 21118682 |  RPU Motor Brushes - Lemac (Long) for RPU300 | 88.00 | 104.72 |
| 000-13960-001 |  Brush replacements for RPU80, RPU160 and RPU300 pumps with Parvalux motors. | 83.00 | 98.77 |
| 000-15942-001 |  Autopilot ORB hose fitting kit for MKII Pumps 1, 2, 3, 4 & 5 | 169.00 | 201.11 |
| 000-14464-001 | NAC-1 & NAC-2 Power Cable - 2m | 38.00 | 45.22 |
| 000-12359-001 |  WR10 BT-1 Base Station Only | 269.00 | 320.11 |
| 000-12358-001 |  WR10 Wireless Remote for Autopilot. | 209.00 | 248.71 |

Accessories

| Part Number | Description | RRP excl. (EUR) | RRP incl. (19.0%) |
|---------------|--------------------------------------------------------------------------------------------------------------------------------------------------------------------------------------------------------------------------------------------------------------|-----------------|-------------------|
| 000-14268-001 |  Waterproof 4-core cable joiner for NAC-1, 2 and 3 Autopilot installations. Convenient way to connect your computer to the drive unit and ensure a waterproof connection. | 27.00 | 32.13 |

















Spare Parts

















| Part Number | Description | RRP excl. (EUR) | RRP incl. (19.0%) |
|-------------|---------------------------------------------------------------------------------------------------------------------------------------------------------------|-----------------|-------------------|
| 20997953 |  RPU80/100/150/160/200 Seal Kit. Works for all motor types and pump sizes. | 97.00 | 115.43 |

| Part Number | Description | RRP excl. (EUR) | RRP incl. (19.0%) |
|---------------|----------------------------------------------------------------------------------------------------------------------------------------------------------------|-----------------|-------------------|
| 21118617 |  RPU80 Motor Brushes - Framco | 58.00 | 69.02 |
| 21118633 |  RPU160 Motor Brushes - Framco | 69.00 | 82.11 |
| 21118625 |  RPU Motor Brushes - Framco for RPU300 | 69.00 | 82.11 |
| 21118666 |  RPU Motor Brushes - Lemac for RPU80/160 | 81.00 | 96.39 |
| 21118682 |  RPU Motor Brushes - Lemac (Long) for RPU300 | 88.00 | 104.72 |
| 000-13960-001 |  Brush replacements for RPU80, RPU160 and RPU300 pumps with Parvalux motors. | 83.00 | 98.77 |

Komunikation









Main Products

| Part Number | Description | RRP excl. (EUR) | RRP incl. (19.0%) |
|---------------|---------------------------------------------------------------------------------------------------------------------------------------------------------------------------------------------------------------------------------------------------------------------|-----------------|-------------------|
| 000-14261-001 |  RS20/V20 Mounting Bracket | 33.00 | 39.27 |
| 000-14913-001 |  V60 VHF Suncover | 22.00 | 26.18 |
| 000-14922-001 |  B&G V60 Remote Mountable Fist Mic. Can be connected to the front or rear of the radio, and optional extension cable allows the radio and mic to be mounted in separate locations. | 77.00 | 91.63 |
| 000-14919-001 |  RS40/V60 Bulkhead Fist Mic Mounting Clip | 9.00 | 10.71 |
| 000-14917-001 |  RS40/V60 VHF Mounting bracket with Knobs and Screws | 27.00 | 32.13 |
| 000-14915-001 |  RS40/V60 VHF Flush Mounting kit.:Includes teplate, Gasket, Bezels and screws | 12.00 | 14.28 |
| 000-14925-001 |  HS40/H60 VHF Wireless handset Inductive charging cradle | 55.00 | 65.45 |
| 000-14923-001 |  5m Extension Cable for RS40, RS40-B, V60, V60B and Link-9 VHF Fist Mics, and H100/HS100 Handsets. | 44.00 | 52.36 |
| 000-14924-001 |  10m Extension Cable for RS40, RS40-B, V60, V60B and Link-9 VHF Fist Mics, and H100/HS100 Handsets. | 55.00 | 65.45 |
| 000-13613-001 |  GPS-500 - GPS antenna for Navico AIS transceivers and VHF systems. 10 m (33 ft) cable with SMA connector. | 149.00 | 177.31 |
| 000-15642-001 |  NRS-2 Marine VHF Radio with built in AIS Class B transceiver. Black box only | 1339.00 | 1593.41 |
| 000-15657-001 |  NRS-1/ NRS-2 Bulkhead WiFi Antenna Mount Cable - 6m - For mounting the WiFi antenna in more suitable location if reception from antenna on Blackbox is not adequate. | 129.00 | 153.51 |
| 000-15653-001 |  CR100 Mounting cradle for HS100 & H100 VHF radio handsets | 20.00 | 23.80 |
| 000-15656-001 |  HS100/H100 Handset cable with bulkhead mount 20m (65.5 ft) | 109.00 | 129.71 |
| 000-11727-001 |  RS90/V90 20m (65 ft) Handset cable. Includes phoenix connector and bulkhead mount | 89.51 | 106.51 |
| AA000355 |  UKW-Antenne Gfk 240 cm | 75.00 | 89.25 |

| Part Number | Description | RRP excl. (EUR) | RRP incl. (19.0%) |
|---------------|---------------------------------------------------------------------------------------------------------------------------------------------------------------------------------------------------------------|-----------------|-------------------|
| AA000358 |  UKW-Antenne Gfk 100 cm | 41.00 | 48.79 |
| AA000223 |  Antennenhalterung Kunststoff mit 5 m Kabel | 36.00 | 42.84 |
| AA000224 |  Antennenhalterung Edelstahl mit 5 m Kabel | 73.00 | 86.87 |
| AA000352 |  UKW-Antenne Mastmontage | 52.00 | 61.88 |
| AA000400 |  VHF extension cable 5 m (16 ft) | 29.00 | 34.51 |
| AA000401 |  VHF mast cable 30 m (98 ft) for 1720 whip antenna. With Quick Fit Connector one end and Masthead connector on the other. | 70.00 | 83.30 |
| 000-15641-001 |  NRS-1 Marine VHF Radio. Black box only | 749.00 | 891.31 |
| 000-10378-001 |  VKIT-9 Einbausatz für versenkten Einbau RS10, RS12 und RS25 | 10.58 | 12.59 |
| 000-11564-001 |  BC-10 VHF Charger w/ US Power Adapter for HH36 and LINK-2 VHF. | 56.65 | 67.41 |
| 000-11562-001 |  BC-10 VHF Charger w/ 12V CIG Plug for HH36 and LINK-2 VHF. | 39.66 | 47.19 |
| 000-15859-001 |  VHF ANTENNA, 1Meter Back Fiberglass Stainless Steel, Quick fit fitting. | 78.00 | 92.82 |
| 000-14806-001 |  V3100 Power cable, 1.8 m (6ft) | 32.00 | 38.08 |
| 000-14807-001 |  V3100 NMEA 0183 Cable 1.8 m (6ft) | 32.00 | 38.08 |
| 000-14263-001 |  RS20/V20 Mounting Bracket Knobs | 16.00 | 19.04 |
| 000-14056-001 |  V20 Suncover | 20.59 | 24.50 |
| 000-14066-001 |  VHF Interface - Type 6. For Simrad RS20/RS40, B&G V20/V60 | 88.00 | 104.72 |







| Part Number | Description | RRP excl. (EUR) | RRP incl. (19.0%) |
|---------------|------------------------------------------------------------------------------------------------------------|-----------------|-------------------|
| 000-14059-001 |  RS20/V20 Flush Mount Kit | 12.00 | 14.28 |

Accessories

| Part Number | Description | RRP excl. (EUR) | RRP incl. (19.0%) |
|---------------|--------------------------------------------------------------------------------------------------------------------------------------------------------------------------------------------------------------|-----------------|-------------------|
| 000-16055-001 |  VHF antenna mount. Heavy-duty stainless steel fold-down antenna mount. With attached 7 m (23 ft) cable. Fastfit connector | 83.50 | 99.37 |
| 000-14923-001 |  5m Extension Cable for RS40, RS40-B, V60, V60B and Link-9 VHF Fist Mics, and H100/HS100 Handsets. | 44.00 | 52.36 |
| 000-14924-001 |  10m Extension Cable for RS40, RS40-B, V60, V60B and Link-9 VHF Fist Mics, and H100/HS100 Handsets. | 55.00 | 65.45 |
| 000-11727-001 |  RS90/V90 20m (65 ft) Handset cable. Includes phoenix connector and bulkhead mount | 89.51 | 106.51 |
| AA000223 |  Antennenhalterung Kunststoff mit 5 m Kabel | 36.00 | 42.84 |
| AA000224 |  Antennenhalterung Edelstahl mit 5 m Kabel | 73.00 | 86.87 |
| AA000400 |  VHF extension cable 5 m (16 ft) | 29.00 | 34.51 |
| AA000401 |  VHF mast cable 30 m (98 ft) for 1720 whip antenna. With Quick Fit Connector one end and Masthead connector on the other. | 70.00 | 83.30 |

















Echo Sounder





Main Products

| Part Number | Description | RRP excl. (EUR) | RRP incl. (19.0%) |
|---------------|-------------------------------------------------------------------------------------------------------------------------------------------------------------|-----------------|-------------------|
| 000-16295-001 | TRANSDUCER/NETWORK CABLE PULLING TOOLS | 24.99 | 29.74 |
| 000-11669-001 |  ForwardScan™ Sleeve and Plug Only (No Transducer) | 218.99 | 260.60 |
| 000-12231-001 |  ForwardScan™ Fairing Block Only | 43.99 | 52.35 |
| 000-12230-001 |  ForwardScan™ Plug Only | 30.85 | 36.71 |
| 000-12232-001 |  ForwardScan™ O-Ring (Color of supplied O-Ring may vary from shown) | 6.49 | 7.72 |
| 000-11224-001 | FAIRING LSS HD BRONZE TRANSDUCER SPARE | 103.99 | 123.75 |
| 000-10567-001 |  P617V DST HSG VLV KIT | 54.00 | 64.26 |
| 000-11040-001 |  Adapts LSS-1 transducers to HDS Gen2 Touch units and to LSS-HD modules. | 108.90 | 129.59 |

Netzwerk













Main Products

| Part Number | Description | RRP excl. (EUR) | RRP incl. (19.0%) |
|---------------|-------------------------------------------------------------------------------------------------------------------------------------------------------------------------------------------|-----------------|-------------------|
| 24005910 |  SimNet power cable without terminator 2 m (6.6 ft) -yellow tip | 31.00 | 36.89 |
| 24005829 |  SimNet cable 0.3 m (1 ft) | 31.00 | 36.89 |
| 24005837 |  SimNet cable 2 m (6.6 ft) | 40.00 | 47.60 |
| 24005845 |  SimNet cable 5 m (16 ft) | 47.00 | 55.93 |
| 24005852 |  SimNet cable 10 m (33 ft) note: for simNet backbone only | 59.00 | 70.21 |
| 24005860 |  SimNet 3 Prong Multi-joiner | 29.00 | 34.51 |
| 24005886 |  SimNet protection plug | 5.00 | 5.95 |
| 24005894 |  SimNet termination plug | 13.00 | 15.47 |
| 24005902 |  SimNet power cable with terminator 2 m (6.6 ft) -red tip | 34.00 | 40.46 |
| 24006199 |  Micro-C female to SimNet 1.0 m (3.2 ft) cable that connects a NMEA 2000® product to a SimNet backbone | 35.00 | 41.65 |
| 24006298 |  SimNet 7 Prong Multi-joiner | 59.00 | 70.21 |
| 24006306 |  SimNet bulkhead T-connector | 65.00 | 77.35 |
| 24006413 |  Micro-C female to SimNet 4 m (13 ft) cable that connects a NMEA 2000® product to a SimNet backbone | 47.00 | 55.93 |
| 44172260 |  SimNet joiner yellow without terminator | 18.00 | 21.42 |
| 44172278 |  SimNet joiner red with terminator | 18.00 | 21.42 |
| 000-00020-001 |  ST10 Simnet Programmier Toolkit | 179.00 | 213.01 |





| Part Number | Description | RRP excl. (EUR) | RRP incl. (19.0%) |
|---------------|-----------------------------------------------------------------------------------------------------------------------------------|-----------------|-------------------|
| SIMKIT-1 |  SimNet Starter Kit-1 | 125.40 | 149.23 |
| 000-10438-001 |  Ethernet-Adapter Direkt RJ45 M auf yellow 5 pin | 37.00 | 44.03 |
| 000-11584-001 |  NMEA0183 Serial Cable - LTW 8 Way - 10M | 43.00 | 51.17 |
| 000-11447-001 |  Spare WIFI-1 Power Cable. | 30.90 | 36.77 |

Andere



Main Products

| Part Number | Description | RRP excl. (EUR) | RRP incl. (19.0%) |
|---------------|--------------------------------------------------------------------------------------------------------------------------------------------------------------------------------------------------------------------------------------------------------------|-----------------|-------------------|
| 000-16055-001 |  VHF antenna mount. Heavy-duty stainless steel fold-down antenna mount. With attached 7 m (23 ft) cable. Fastfit connector | 83.50 | 99.37 |
| 000-15944-001 |  Autopilot fitting adaptor kit. Contains 3 x ORB-5 to 1/4" NPT adaptors | 50.00 | 59.50 |
| 000-15949-001 |  ORB hose fitting kit for MKII Pumps 1, 2, 3, 4 & 5, including SteadySteer | 569.00 | 677.11 |
| 000-15858-001 |  PUMP-X Motor Brushes - Autopilot pump brush kit for PUMP-2,3,4 & 5. 2Pcs. Note: Not for Pump-1 | 65.00 | 77.35 |
| 000-14968-001 |  Navico 1710 VHF antenna, 2.5 m (8 ft) ultraglass, quickfit @ 6dB BLACK | 88.00 | 104.72 |
| 000-14495-001 | V90S Blackbox VHF with AIS (receive only) Conforms to new EU Standard | 709.67 | 844.51 |
| 000-14798-001 |  NAC-2 Rudder feedback cable: Used to connect resistive rudder feedback units to either NAC-1 or NAC-2. 3 Pin connector to 3 bare wires. 2 m (6.5 ft) | 38.00 | 45.22 |
| 000-14352-001 | SERVICE PACK FOR SIMNET TERMINATOR | 12.46 | 14.83 |
| 000-14268-001 |  Waterproof 4-core cable joiner for NAC-1, 2 and 3 Autopilot installations. Convenient way to connect your computer to the drive unit and ensure a waterproof connection. | 27.00 | 32.13 |
| 000-14060-001 |  LINK-6 Mounting Bracket | 33.00 | 39.27 |
| 000-14064-001 |  LINK-6 Mounting Bracket Knobs | 16.00 | 19.04 |
| BGH301035 |  B&G SimNet Kabel 0.35m, gewinkelt | 36.00 | 42.84 |
| 000-12265-001 |  VMHU MAST CABLE 80M | 952.75 | 1133.77 |
| 000-12266-001 |  213 MAST CABLE,80M | 952.75 | 1133.77 |
| 213-10-003 |  213 Windmeßgeber nur Gehäuse (Standart Version) | 480.00 | 571.20 |
| 000-14503-001 | LINKPRO SERVICE TOOL | 219.00 | 260.61 |

Accessories

| Part Number | Description | RRP excl. (EUR) | RRP incl. (19.0%) |
|---------------|-------------------------------------------------------------------------------------------------------------------------------------------------------------------------------------------------------------|-----------------|-------------------|
| 000-16055-001 |  VHF antenna mount. Heavy-duty stainless steel fold-down antenna mount. With attached 7 m (23 ft) cable. Fastfit connector | 83.50 | 99.37 |
| AA000223 |  Antennenhalterung Kunststoff mit 5 m Kabel | 36.00 | 42.84 |
| AA000224 |  Antennenhalterung Edelstahl mit 5 m Kabel | 73.00 | 86.87 |
| AA000400 |  VHF extension cable 5 m (16 ft) | 29.00 | 34.51 |
| BGH301035 |  B&G SimNet Kabel 0.35m, gewinkelt | 36.00 | 42.84 |

Spare Parts

| Part Number | Description | RRP excl. (EUR) | RRP incl. (19.0%) |
|-------------|-----------------------------------------------------------------------------------------------------------------------------------|-----------------|-------------------|
| BGH231021 |  Missing Image H3000 Analog: Echolot ft/fathoms | 28.00 | 33.32 |
| BGH234017 |  H3000 analog Schutzkappen | 18.00 | 21.42 |

Voll-Version

Main Products

| Part Number | Description | RRP excl. (EUR) | RRP incl. (19.0%) |
|-------------|-----------------------------------------------------------------------------------------------------------------|--------------------|----------------------|
| BGH140001 |  Deckman C-MAP Version mit USB | 1329.00 | 1581.51 |
| BGH140010 |  Deckman Upgrade +1 Version | 475.00 | 565.25 |